

CONCRETE PROJECT

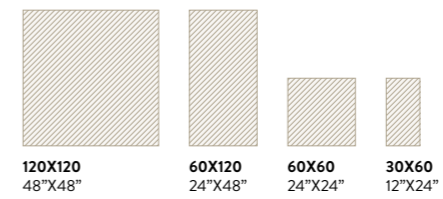

CONCRETE PROJECT



GRES PORCELLANATO A TUTTO SPESSORE
FULL BODY PORCELAIN TILES





CONCRETE PROJECT

CONPROJ R12DG

CONPROJ R12W

CONPROJ RB60G

CONCRETE PROJECT

CONPROJ120DG

CONPROJ120G



CONCRETE PROJECT

CONPROJ120DG

CONPROJ120G



CONCRETE PROJECT

CONPROJ 12DG

CONPROJ 12MU

CONPROJ 120W

CONPROJ 36DG

LCONPROJ 10MU



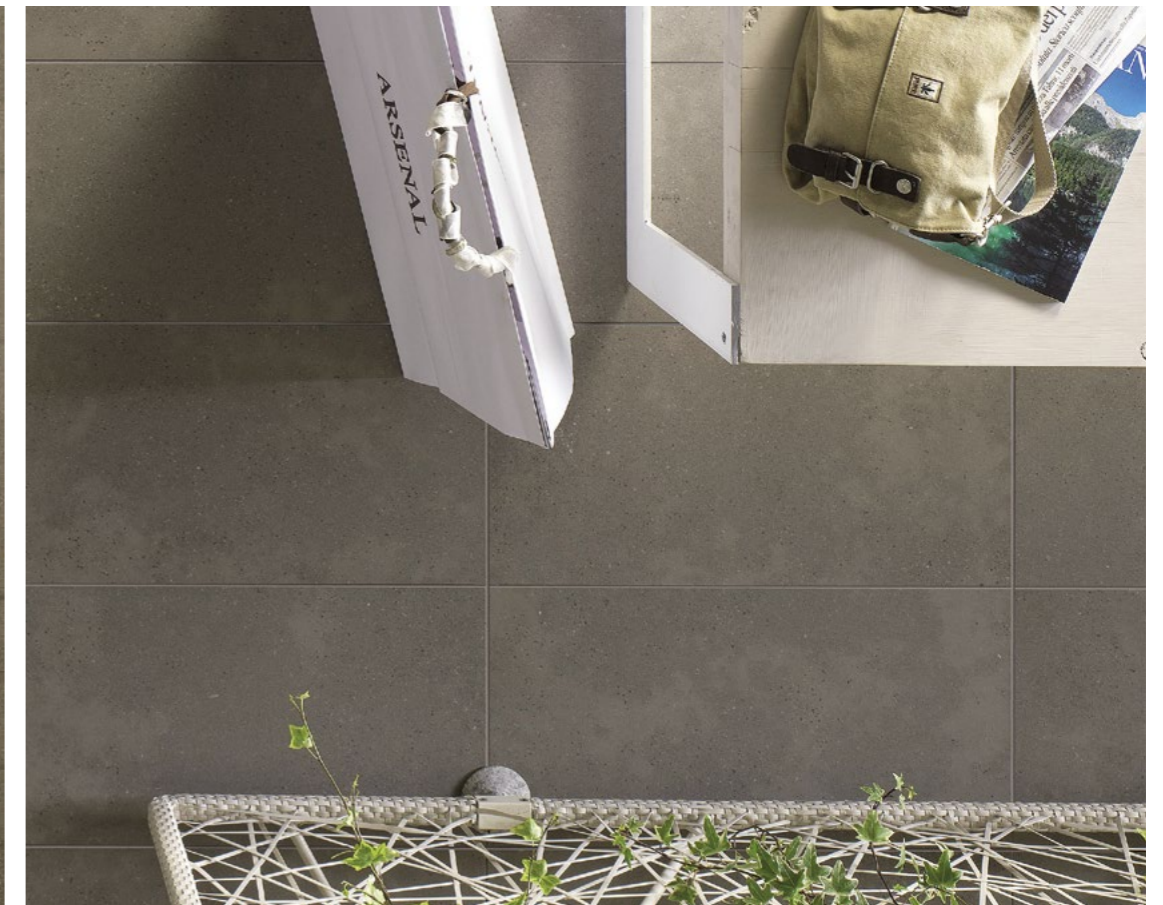

CONPROJ R12B
CONPROJ 12A LP

CONCRETE PROJECT



CONPROJ R12B
CONPROJ 12A LP

CONCRETE PROJECT





CONCRETE PROJECT

CONPROJ 12N

LCONPROJ 10N

LCONPROJ 20N

LCONPROJ 30N



CONCRETE PROJECT

- CONPROJ 12N
- LCONPROJ 10N
- LCONPROJ 20N
- LCONPROJ 30N

CONCRETE PROJECT

CONPROJ120R



GRES PORCELLANATO A TUTTO SPESSORE / FULL BODY PORCELAIN TILES

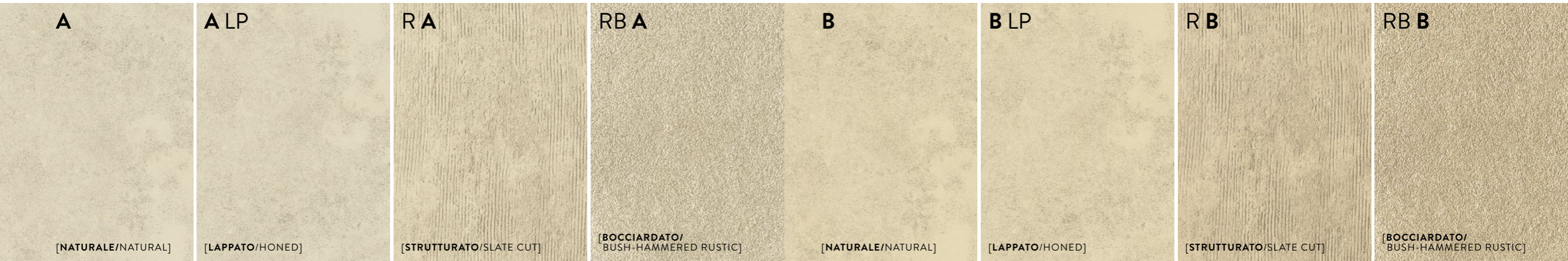
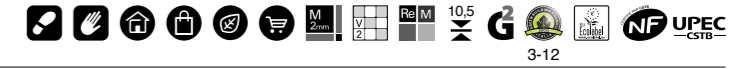

120X120-48"X48"

CONPROJ 120A
CONPROJ 120A LP

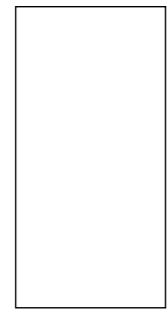

60X120-24"X48"

CONPROJ 12A
CONPROJ 12A LP
CONPROJ R12A



60X60-24"X24"

CONPROJ 60A
CONPROJ 60A LP
CONPROJ RB60A



30X60-12"X24"

CONPROJ 36A
CONPROJ 36A LP
CONPROJ R36A
CONPROJ RB36A



120X120-48"X48"

CONPROJ 120B
CONPROJ 120B LP

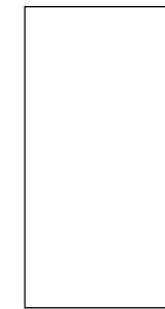

60X120-24"X48"

CONPROJ 12B
CONPROJ 12B LP
CONPROJ R12B

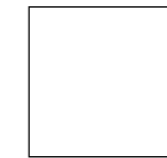

60X60-24"X24"

CONPROJ 60B
CONPROJ 60B LP
CONPROJ RB60B

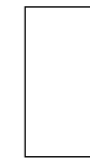

30X60-12"X24"

CONPROJ 36B
CONPROJ 36B LP
CONPROJ R36B
CONPROJ RB36B



MK.CONPROJ 30A
30X30-12"X12"



MU.CONPROJ 36A
30X60-12"X24" ▲



MK.CONPROJ 30B
30X30-12"X12"



MU.CONPROJ 36B
30X60-12"X24" ▲

GRES PORCELLANATO A TUTTO SPESSORE / FULL BODY PORCELAIN TILES

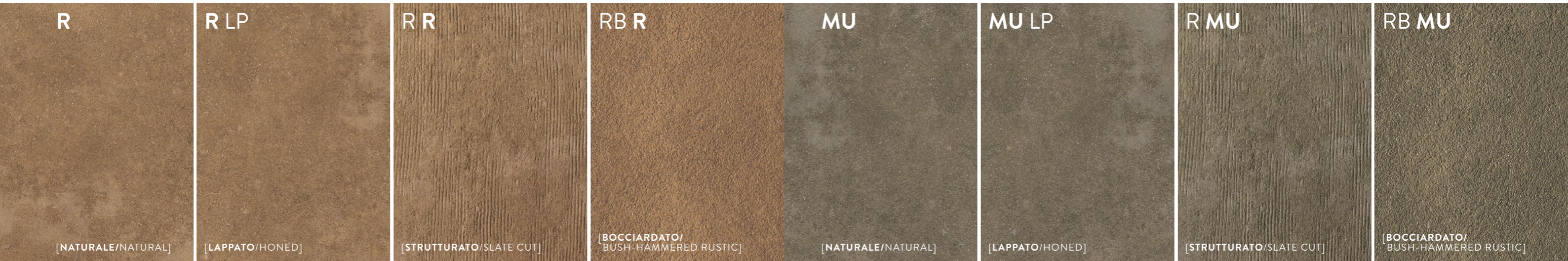
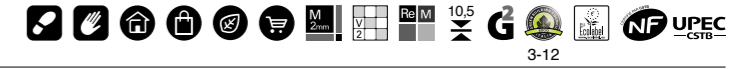

[NATURALE/NATURAL]

[LAPPATO/HONED]

[STRUTTURATO/SLATE CUT]

[BOCCIARDATO/
BUSH-HAMMERED RUSTIC]

[NATURALE/NATURAL]

[LAPPATO/HONED]

[STRUTTURATO/SLATE CUT]

[BOCCIARDATO/
BUSH-HAMMERED RUSTIC]

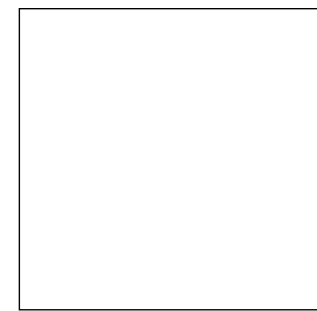

120X120-48"X48"

CONPROJ 120R
CONPROJ 120R LP

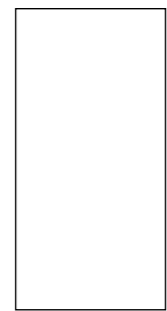

60X120-24"X48"

CONPROJ 12R
CONPROJ 12R LP
CONPROJ R12R



60X60-24"X24"

CONPROJ 60R
CONPROJ 60R LP
CONPROJ RB60R



30X60-12"X24"

CONPROJ 36R
CONPROJ 36R LP
CONPROJ R36R
CONPROJ RB36R

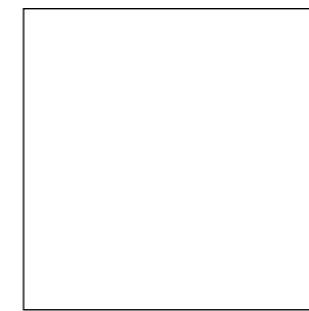

120X120-48"X48"

CONPROJ 120MU
CONPROJ 120MULP



60X120-24"X48"

CONPROJ 12MU
CONPROJ 12MULP
CONPROJ R12MU

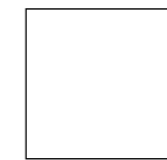

60X60-24"X24"

CONPROJ 60MU
CONPROJ 60MULP
CONPROJ RB60MU



30X60-12"X24"

CONPROJ 36MU
CONPROJ 36MULP
CONPROJ R36MU
CONPROJ RB36MU



30X120-12"X48"

L.CONPROJ 30MU



20X120-8"X48"

L.CONPROJ 20MU



10X120-4"X48"

L.CONPROJ 10MU



MK.CONPROJ 30R
30X30-12"X12"

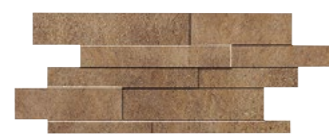

MU.CONPROJ 36R
30X60-12"X24"

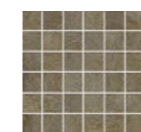

MK.CONPROJ 30MU
30X30-12"X12"

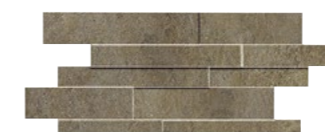

MU.CONPROJ 36MU
30X60-12"X24"

GRES PORCELLANATO A TUTTO SPESSORE / FULL BODY PORCELAIN TILES

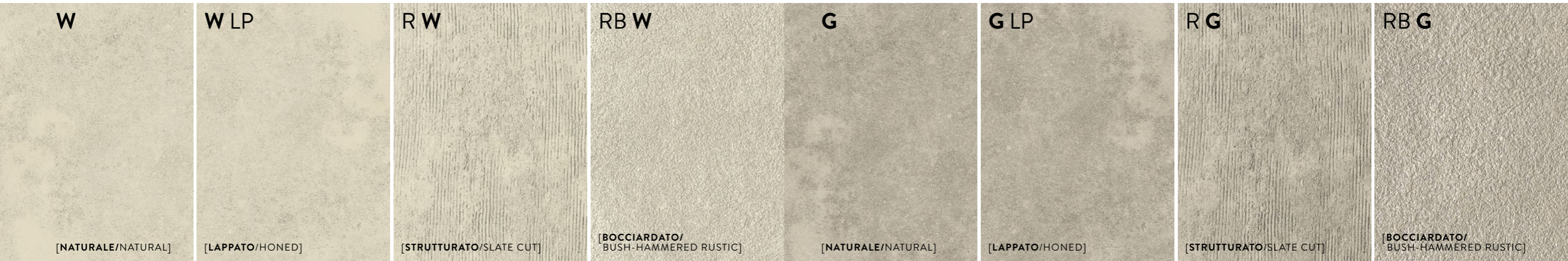
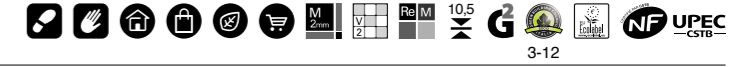

N LI

LP LI

N ST

N RB

N LI

LP LI

N ST

N RB

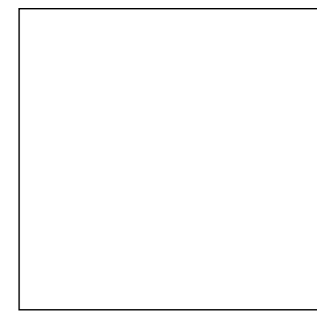

120X120-48"X48"

CONPROJ 120W
CONPROJ 120W LP



60X120-24"X48"

CONPROJ 12W
CONPROJ 12W LP
CONPROJ R12W

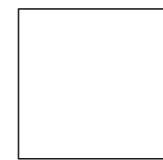

60X60-24"X24"

CONPROJ 60W
CONPROJ 60W LP
CONPROJ RB60W



30X60-12"X24"

CONPROJ 36W
CONPROJ 36W LP
CONPROJ R36W
CONPROJ RB36W

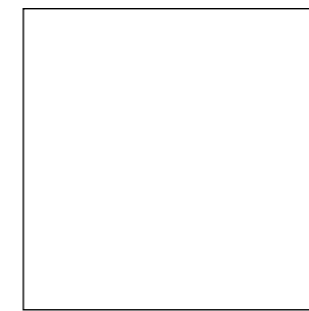

120X120-48"X48"

CONPROJ 120G
CONPROJ 120G LP



60X120-24"X48"

CONPROJ 12G
CONPROJ 12G LP
CONPROJ R12G

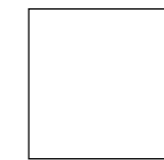

60X60-24"X24"

CONPROJ 60G
CONPROJ 60G LP
CONPROJ RB60G



30X60-12"X24"

CONPROJ 36G
CONPROJ 36G LP
CONPROJ R36G
CONPROJ RB36G



30X120-12"X48"

L.CONPROJ 30G



20X120-8"X48"

L.CONPROJ 20G



10X120-4"X48"

L.CONPROJ 10G

N LI



MK.CONPROJ 30W
30X30-12"X12"

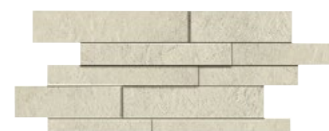

MU.CONPROJ 36W
30X60-12"X24"



N LI



MK.CONPROJ 30G
30X30-12"X12"



MU.CONPROJ 36G
30X60-12"X24"



GRES PORCELLANATO A TUTTO SPESSORE / FULL BODY PORCELAIN TILES

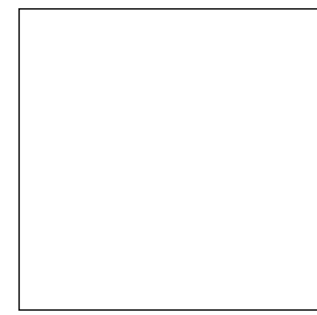
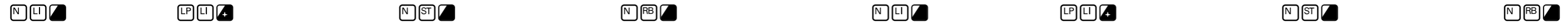
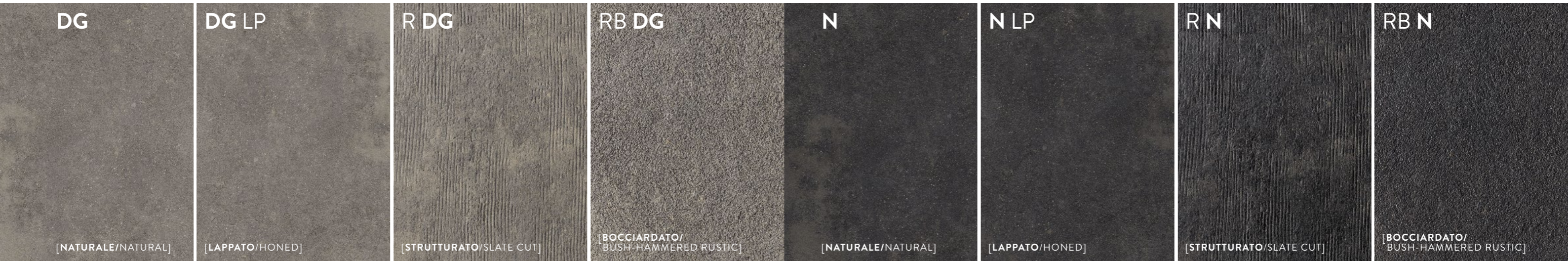
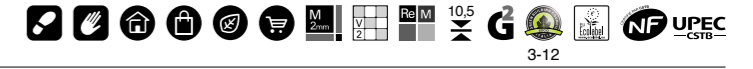

120X120-48"X48"

CONPROJ 120DG
CONPROJ 120DGLP

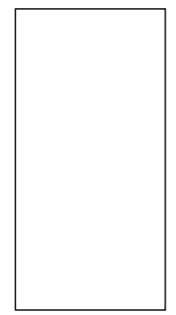

60X120-24"X48"

CONPROJ 12DG
CONPROJ 12DGLP
CONPROJ R12DG

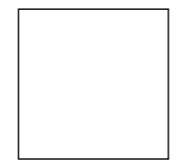

60X60-24"X24"

CONPROJ 60DG
CONPROJ 60DGLP
CONPROJ RB60DG



30X60-12"X24"

CONPROJ 36DG
CONPROJ 36DGLP
CONPROJ R36DG
CONPROJ RB36DG

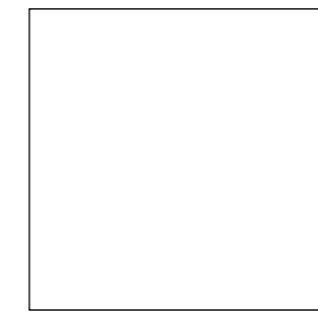

120X120-48"X48"

CONPROJ 120N
CONPROJ 120N LP



60X120-24"X48"

CONPROJ 12N
CONPROJ 12N LP
CONPROJ R12N

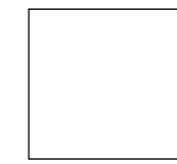

60X60-24"X24"

CONPROJ 60N
CONPROJ 60N LP
CONPROJ RB60N



30X60-12"X24"

CONPROJ 36N
CONPROJ 36N LP
CONPROJ R36N
CONPROJ RB36N

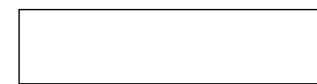

30X120-12"X48"

L.CONPROJ 30DG

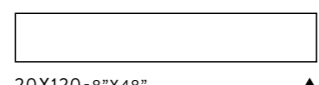

20X120-8"X48"

L.CONPROJ 20DG

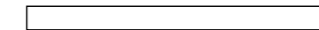

10X120-4"X48"

L.CONPROJ 10DG

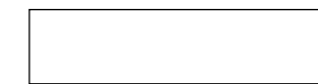

30X120-12"X48"

L.CONPROJ 30N

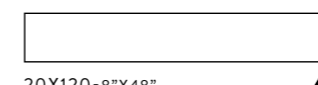

20X120-8"X48"

L.CONPROJ 20N

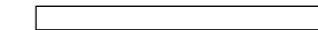

10X120-4"X48"

L.CONPROJ 10N

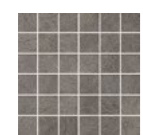

MK.CONPROJ 30DG
30X30-12"X12"



MU.CONPROJ 36DG
30X60-12"X24"

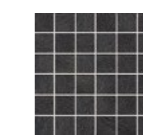
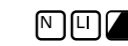

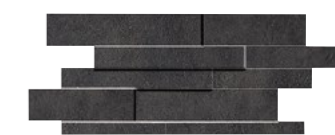

MK.CONPROJ 30N
30X30-12"X12"

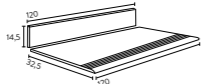

MU.CONPROJ 36N
30X60-12"X24"

PEZZI SPECIALI / SPECIAL PIECES

	 9,5X60-3.7"X24" ▲	 60X120-24"X48" ▲	 120X32,5-48"X12.8" ▲	 120X32,5-48"X12.8" ▲
[A]	CONPROJ BT 60A	CONPROJ KIT 12A	CONPROJ G120A	CONPROJ A120ADX CONPROJ A120ASX
[B]	CONPROJ BT 60B	CONPROJ KIT 12B	CONPROJ G120B	CONPROJ A120BDX CONPROJ A120BSX
[R]	CONPROJ BT 60R	CONPROJ KIT 12R	CONPROJ G120R	CONPROJ A120RDX CONPROJ A120RSX
[MU]	CONPROJ BT 60MU	CONPROJ KIT 12MU	CONPROJ G120MU	CONPROJA120MUDX CONPROJA120MUSX
[W]	CONPROJ BT 60W	CONPROJ KIT 12W	CONPROJ G120W	CONPROJ A120WDX CONPROJ A120WSX
[G]	CONPROJ BT 60G	CONPROJ KIT 12G	CONPROJ G120G	CONPROJ A120GDX CONPROJ A120GSX
[DG]	CONPROJ BT 60DG	CONPROJ KIT 12DG	CONPROJ G120DG	CONPROJA120DGDX CONPROJA120DGSX
[N]	CONPROJ BT 60N	CONPROJ KIT 12N	CONPROJ G120N	CONPROJ A120NDX CONPROJ A120NSX

CARATTERISTICHE TECNICHE SPECIFICHE / TECHNICAL FEATURES SPECIFICATIONS

	DIN 51130 (R)	DIN 51097 (A+B+C)	BOT 3000 (DCOF)	BCR REP. CEC 6/81		DM 14/6/89 N. 236	
				G.A.	G.B.	C.A.	G.B.
CONPROJ	R10	A	>0,42	>0,4	>0,4	>0,4	>0,4
CONPROJ RB	R11	A+B	>0,42	>0,4	>0,4	>0,4	>0,4
CONPROJ R	R11	A+B	>0,42	>0,4	>0,4	>0,4	>0,4



CONPROJ 12A LP

SIMBOLOGIA SYMBOLS

INDICAZIONI D'USO. INDICATIONS FOR USE.



PAVIMENTO.
FLOOR TILES.



RIVESTIMENTO.
WALL TILES.

FINITURA. FINISH.



NATURALE.
NATURAL.



LAPPATO.
HONED.

BORDO. EDGE.



RETTIFICATO MONOCALIBRO.
MONOCALIBER, RECTIFIED.

STRUTTURA. STRUCTURE.



LISCIO.
SMOOTH.



STUTTURATO.
SLATE CUT.



BOCCIARDATO.
BUSH-HAMMERED RUSTIC.

DESTINAZIONI D'USO. SUGGESTED APPLICATIONS.



ABITAZIONI.
DOMESTIC PURPOSE.



COMMERCIALE LEGGERO.
TILES FOR LIGHT COMMERCIAL TRAFFIC AREA.



COMMERCIALE PESANTE.
TILES FOR HEAVY TRAFFIC AREA.



ESTERNI.
OUTDOOR FLOOR.

MODULARE. MODULAR.



MODULARE 2 mm
MODULAR 2 MM

ASPETTO SUPERFICIALE. SURFACE LOOK.



OPACO.
MATT.



SEMILUCIDO.
SEMI-GLOSSY.

CARATTERISTICHE DI VENDITA. SALES CHARACTERISTICS.

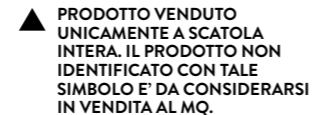

PRODOTTO VENDUTO UNICAMENTE A SCATOLA INTERA. IL PRODOTTO NON IDENTIFICATO CON TALE SIMBOLO E' DA CONSIDERARSI IN VENDITA AL MQ.

PRODUCT SOLD ONLY IN COMPLETE BOXES. IF THE PRODUCT IS NOT MARKED WITH THIS SYMBOL IT SHOULD BE CONSIDERED AS SOLD BY M².

STONALIZZAZIONE. SHADE VARIATION.



V2

CERTIFICAZIONI CERTIFICATIONS

LA NATURA E LA TECNOLOGIA SI FONDONO PER DAR VITA A UN NUOVO CONCETTO DI CERAMICA CHE METTE AL CENTRO IL RAPPORTO TRA L'UOMO E L'AMBIENTE; UN BINOMIO INSCINDIBILE PER IL CONSEGUIMENTO CONSAPEVOLE DEI PRINCIPI DI ECO-EFFICIENZA AZIENDALE ED ECO-COMPATIBILITÀ AMBIENTALE SIGILLATO DA IMPORTANTI RICONOSCIMENTI.

NATURE AND TECHNOLOGY COMBINE TO GIVE BIRTH TO A NEW CONCEPT IN CERAMIC TILES WHICH PLACES THE RELATIONSHIP BETWEEN MAN AND THE ENVIRONMENT AT THE CENTRE; AN INSEPARABLE COMBINATION FOR THE CONSCIOUS ACHIEVEMENT OF ECO-EFFICIENT CORPORATE PRINCIPLES AS WELL AS THOSE OF ENVIRONMENTAL ECO-COMPATIBILITY, SEALED WITH IMPORTANT RECOGNITIONS.

ISO 14001

IL SISTEMA DI GESTIONE AMBIENTALE DI COOPERATIVA CERAMICA D'IMOLA - IN RIFERIMENTO ALLA NORMA UNI EN ISO 14001 - È STATO IMPOSTATO PERSEGUENDO I SEGUENTI PRINCIPI:

- SALVAGUARDIA DELL'AMBIENTE E DELLE RISORSE NATURALI.
- POLITICA ENERGETICA EFFICACE ED EFFICIENTE.
- RISPETTO PER L'ECOSISTEMA.

THE ENVIRONMENTAL MANAGEMENT SYSTEM OF COOPERATIVA CERAMICA D'IMOLA - IN REFERENCE TO THE UNI EN ISO 14001 NORMATIVE - WAS IMPOSED ON THE BASIS OF THE FOLLOWING PRINCIPLES:

- PROTECTION OF THE ENVIRONMENT AND OF NATURAL RESOURCES.
- EFFICIENT AND EFFECTIVE ENERGY POLICY.
- RESPECT FOR THE ECOSYSTEM.



ISO 9001

COOPERATIVA CERAMICA D'IMOLA HA OTTENUTO LA CERTIFICAZIONE DEL SISTEMA DI QUALITÀ IN RIFERIMENTO ALLA NORMA UNI EN ISO 9001, PER LA PROGETTAZIONE, PRODUZIONE E VENDITA DI PIASTRELLE CERAMICHE IN TUTTE LE TIPOLOGIE PRODUTTIVE.

L'IMPLEMENTAZIONE DI TALE SISTEMA HA I SEGUENTI OBIETTIVI:

- PERSEGUIRE, ATTRAVERSO UN'ADEGUATA GESTIONE DELLE RISORSE TECNICHE E IMPIANTISTICHE, IL CONTINUO MIGLIORAMENTO DEI PROCESSI PRODUTTIVI;
- GARANTIRE IL CORRETTO IMPIEGO, L'EFFICIENZA, L'ATTENDIBILITÀ ED AFFIDABILITÀ DEI RISULTATI DI MISURE E PROVE, ATTRAVERSO LA PIANIFICAZIONE DELLA MANUTENZIONE ED IL CONTROLLO DI IMPIANTI, APPARECCHIATURE E STRUMENTAZIONI;
- CONTRIBUIRE AL MIGLIORAMENTO DEL CONTESTO SOCIALE DI CUI È PARTE, NEL RISPETTO DELLE PERSONE E DELL'AMBIENTE IN CUI È INTEGRATA.

COOPERATIVA CERAMICA D'IMOLA HAS OBTAINED THE QUALITY SYSTEM CERTIFICATION, IN RELATION TO THE UNI EN ISO 9001 NORMATIVE, FOR THE DESIGN, PRODUCTION AND MARKETING OF CERAMIC TILES FOR ALL OF THE PRODUCTION TYPES.

IMPLEMENTATION OF THIS SYSTEM - IN RELATION TO THE UNI EN ISO 9001 NORMATIVE - HAS THE FOLLOWING OBJECTIVES:

- ACHIEVEMENT, THROUGH ADEQUATE MANAGEMENT OF THE TECHNICAL AND SYSTEM RESOURCES, OF THE ONGOING IMPROVEMENT OF THE PRODUCTION PROCESSES.
- GUARANTEE THE CORRECT USE, EFFICIENCY, RELIABILITY AND DEPENDABILITY OF THE RESULTS OF THE MEASUREMENTS AND TESTS THROUGH THE PLANNING OF THE MAINTENANCE AND THE CONTROL OF THE SYSTEMS, EQUIPMENT AND INSTRUMENTATION.
- CONTRIBUTE TO THE IMPROVEMENT OF THE SOCIAL CONTEXT OF WHICH IT IS PART AND IN TERMS OF THE PEOPLE AND THE ENVIRONMENT INTO WHICH IT IS INTEGRATED.



EMAS

COOPERATIVA CERAMICA D'IMOLA, ATTUANDO UNA PRECISA POLITICA AZIENDALE DI SVILUPPO SOSTENIBILE, HA OTTENUTO LA REGISTRAZIONE ECO-MANAGEMENT AND AUDIT SCHEME (EMAS), UN IMPORTANTE RICONOSCIMENTO A LIVELLO EUROPEO, RELATIVO AI SITI PRODUTTIVI, VOLTO AL CONTINUO MIGLIORAMENTO DEGLI STANDARD PRODUTTIVI E ALLA SENSIBILIZZAZIONE DI TUTTO IL PERSONALE SOTTO IL PROFILO DELLA SALVAGUARDIA AMBIENTALE.

THROUGH THE IMPLEMENTATION OF A PRECISE COMPANY POLICY ON SUSTAINABLE DEVELOPMENT, COOPERATIVA CERAMICA D'IMOLA HAS OBTAINED ECO-MANAGEMENT AND AUDIT SCHEME (EMAS) REGISTRATION. THIS IS AN IMPORTANT RECOGNITION ON A EUROPEAN LEVEL THAT AIM AT THE CONTINUOUS IMPROVEMENT OF PRODUCTION STANDARDS AND AWARENESS OF ALL OF ITS EMPLOYEES IN TERMS OF PROTECTING THE ENVIRONMENT. THE EMAS SYSTEM IS A VOLUNTARY AWARENESS FOR THOSE COMPANIES COMMITTED TO EVALUATING AND IMPROVING THEIR ENVIRONMENTAL EFFICIENCY THROUGH A MORE RESPONSIBLE CHOICE OF BUYING AND MANAGEMENT, A MORE CAREFUL USE OF AIR, WATER, TERRITORY, RAW MATERIALS AND ENERGY.



LEED

COOPERATIVA CERAMICA D'IMOLA È MEMBRO DEL GREEN BUILDING COUNCIL ITALIA, CHE OPERA PER LA DIFFUSIONE DEI CRITERI DEL MARCHIO LEED. LE PIASTRELLE, IN RELAZIONE ALLE CARATTERISTICHE E AL PROCESSO PRODUTTIVO CON CUI SONO REALIZZATE, POSSONO CONTRIBUIRE AD OTTENERE CREDITI L.E.E.D (LEADERSHIP IN ENERGY AND ENVIRONMENTAL DESIGN). IL LEED È UN SISTEMA DI CERTIFICAZIONE ENERGETICO - AMBIENTALE DEGLI EDIFICI CHE PREVEDE L'ATTRIBUZIONE DI UN PUNTEGGIO, ASSEGNATO IN FUNZIONE DELLA COMPROVATA CONFORMITÀ RISPETTO AD ALCUNI "CREDITI" PRESTABILITI. TALE CONTRIBUTO VA VALUTATO NEL TOTALE DEI MATERIALI UTILIZZATI NELL'EDIFICIO.

COOPERATIVA CERAMICA D'IMOLA IS A MEMBER OF THE GREEN BUILDING COUNCIL ITALIA, WHICH OPERATES FOR THE DIFFUSION OF THE LEED ACCREDITATION SYSTEM. IN RELATION TO THE CHARACTERISTICS AND PRODUCTION PROCESS IN WHICH THEY ARE MANUFACTURED, TILES CAN CONTRIBUTE TO OBTAINING L.E.E.D (LEADERSHIP IN ENERGY AND ENVIRONMENTAL DESIGN) CREDITS. LEED IS AN ENERGY-ENVIRONMENTAL ACCREDITATION SYSTEM FOR BUILDINGS AND IS CHARACTERISED BY A POINTS SYSTEM ATTRIBUTED ACCORDING TO THE VERIFIED CONFORMITY OF SEVERAL PRE-ESTABLISHED "CREDITS". THIS CONTRIBUTION IS EVALUATED OVER THE TOTAL OF MATERIALS USED IN THE BUILDING.





IMOLACERAMICA.IT

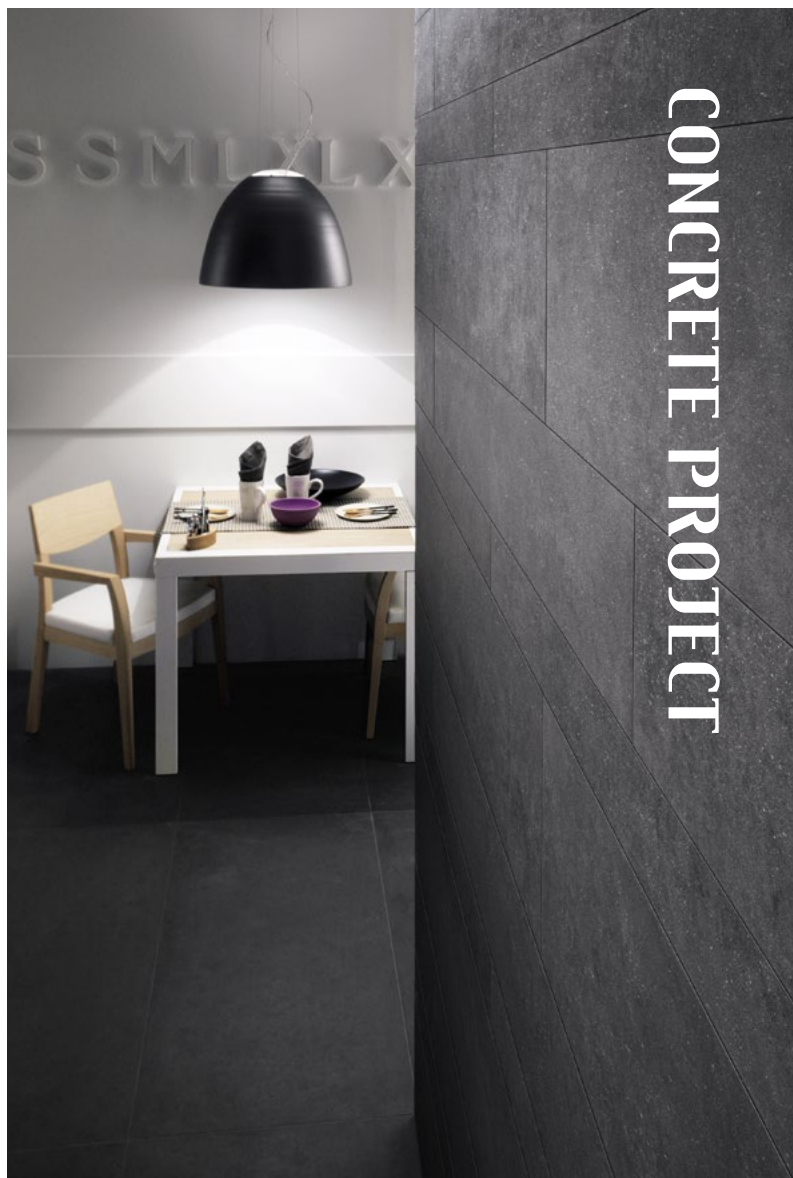

A brand of
Cooperativa Ceramica d'Imola S.c.

Via V. Veneto, 13
40026 Imola (BO) Italia
Tel. +39 0542 601601
Fax +39 0542 31749
