

# Cement Vibes

8 COLOURS

5 SIZES

2 SURFACES

Inspired by concrete and its different chromatic shades, the Cement Vibes collection reinterprets a material that has always existed. The two variations, Solid and Resin, are shown with all their details and characteristics: the more structural, vibrant essence, and the more fluid, contemporary aspect of concrete.

Ispirata al cemento e alle sue differenti tonalità cromatiche, la collezione Cement Vibes reinterpreta una materia che esiste da sempre. Le due declinazioni Solid e Resin vengono mostrate con tutti i loro dettagli e caratteristiche: l'anima più strutturale, solida, vibrante e l'anima più fluida, più minimal, contemporanea del cemento.

Inspiriert vom Beton und seinen verschiedenen Farbtönen, interpretiert die Kollektion Cement Vibes ein Material, das schon immer existiert, neu. Die beiden Ausführungen Solid und Resin werden mit all ihren Details und Eigenschaften gezeigt: die strukturellere, festere, lebendigere Seele und die flüssigere, minimalistischere, zeitgenössische Seele des Betons.

Inspirée par le béton et ses différentes nuances chromatiques, la collection Cement Vibes réinterprète une matière qui existe depuis toujours. Les deux déclinaisons Solid et Resin sont montrées avec tous leurs détails et caractéristiques : l'âme plus structurale, solide et vibrante, et l'âme plus fluide, plus minimaliste et contemporaine du béton.

## Cement Vibes



120x120 - 48"x48" Beton Solid Antislip Rettificato

Spazi Residenziali  
Residential Spaces

P. 4

Spazi Pubblici  
Public Areas

P. 21

Informazioni Tecniche  
Technical Information

P. 35



### CEMENT VIBES

Il cemento è versatile e resistente e ciò lo rende uno dei materiali più utilizzati nell'edilizia e nella creazione di superfici moderne ed eleganti.

Con la Cement Vibes abbiamo creato una serie trasversale in cui le due finiture, Solid e Resin, possono essere combinate tra loro oppure vivere separatamente. La prima è composta da più elementi, è meno pura, più materica. La Resin, invece, ha delle caratteristiche più moderne perché è omogenea e con una tinta più uniforme.

La struttura decorativa Handmade, declinata nei diversi colori dei fondi, completa la collezione.

Cement is versatile and resistant, making it one of the most used materials in construction and in the creation of modern and elegant surfaces.

With Cement Vibes we have created a transversal line in which the two finishes, Solid and Resin, can be combined with each other or exist separately. The first is composed of several elements, is less pure, more material. Resin, on the other hand, has more modern characteristics because it is homogeneous and with a more uniform color. The decorative Handmade structure, available in the different colors of the bases, completes the collection.

Beton ist vielseitig und robust, was ihn zu einem der am häufigsten verwendeten Materialien im Bauwesen und bei der Schaffung moderner und eleganter Oberflächen macht. Mit Cement Vibes haben wir eine vielseitige Serie geschaffen, bei der die beiden Oberflächen, Solid und Resin, miteinander kombiniert oder separat verwendet werden können. Die erste besteht aus mehreren Elementen, ist weniger rein, mehr materialistisch. Die Resin hingegen hat modernere Eigenschaften, da sie homogen und mit einer gleichmäßigeren Farbe ist. Die dekorative Struktur Handmade, die in den verschiedenen Farben der Basisvarianten angeboten wird, vervollständigt die Kollektion.

Le ciment est polyvalent et durable, ce qui en fait l'un des matériaux les plus utilisés dans la construction et dans la création de surfaces modernes et élégantes.

Avec Cement Vibes, nous avons créé une série transversale dans laquelle les deux finitions, Solid et Resin, peuvent être combinées ou vivre séparément. La première est composée de plus d'éléments, elle est moins pure, plus matérielle. La résine, en revanche, présente des caractéristiques plus modernes car elle est homogène et a une teinte plus uniforme.

La structure décorative Handmade, disponible dans différentes couleurs de fond, complète la collection.



# Spazi Residenziali

Residential Spaces  
Wohnanlagen  
Espaces Résidentiels



COLORI / COLOURS

AMBIENTI / AMBIENT

PAGINA / PAGE

Beton Solid	Living	6
Malta Solid / Malta Resin Cannelé	Living	8
Fango Resin	Kitchen	10
Calce Solid - Resin / Handmade Calce	Bathroom	12
Fango Resin / Calce Resin	Bedroom	16
Fango Solid / Handmade Fango	Bathroom	18

Cement Vibes  
Residential Spaces

Malta Solid / Malta Resin Canneté

60x120 - 24"x48" Malta Solid Naturale Rettificato  
20x120 - 8"x48" Malta Resin Canneté



60x120 - 24"x48" Malta Solid Naturale Rettificato





Concrete surfaces offer an industrial and elegant look, giving a touch of class and originality to domestic environments.

Betonoberflächen bieten ein industrielles und elegantes Erscheinungsbild und verleihen Wohnräumen einen Hauch von Klasse und Originalität.

Les surfaces en ciment offrent un aspect industriel et élégant, apportant une touche de classe et d'originalité aux environnements domestiques.

Le superfici in cemento offrono un aspetto industriale ed elegante, conferendo un tocco di classe e originalità agli ambienti domestici.



## Calce Solid / Calce Resin

The selected colors are natural, warm colors that make the environment more welcoming and comfortable: Calce is associated with authenticity, Beton is the shade closest to the real color of cement, Malta is the most elegant and, finally, Fango is a neutral color that gives warmth to the spaces.

Die gewählten Farben sind natürliche, warme Töne, die den Raum einladender und komfortabler machen: Calce wird mit Authentizität in Verbindung gebracht, Beton ist der Ton, der der tatsächlichen Farbe von Beton am nächsten kommt, Malta ist der eleganteste und schließlich ist Fango eine neutrale Farbe, die den Räumen Wärme verleiht.

Les couleurs choisies sont des couleurs naturelles et chaudes qui rendent l'environnement plus accueillant et confortable : Calce est associé à l'authenticité, Béton est la teinte la plus proche de la couleur réelle du ciment, Malta est la plus élégante et, enfin, Fango est une couleur neutre qui confère de la chaleur aux espaces.

I colori scelti sono dei colori naturali, caldi che rendono l'ambiente più accogliente e confortevole: il Calce è associato all'autenticità, il Beton invece è la tonalità più vicina al colore reale del cemento, il Malta è il più elegante e, infine, il Fango è un colore neutro che conferisce calore agli spazi.

120x280 - 48"x110" Calce Resin Naturale Rettificato  
120x120 - 48"x48" Calce Solid Naturale Rettificato



## Fango Resin / Calce Resin

With Cement Vibes you can create a modern and minimalist atmosphere that integrates perfectly with any style of furniture.

Mit Cement Vibes lässt sich eine moderne und minimalistische Atmosphäre schaffen, die sich perfekt in jeden Einrichtungsstil einfügt.

Avec Cement Vibes, il est possible de créer une atmosphère moderne et minimaliste qui se marie parfaitement avec n'importe quel style d'ameublement.

Con Cement Vibes è possibile creare un'atmosfera moderna e minimalista che si integra perfettamente con qualsiasi stile di arredamento.

120×280 - 48"×110" Calce Resin Naturale Rettificato

60×120 - 24"×48" Fango Resin Naturale Rettificato



Cement Vibes  
Residential Spaces

Fango Solid / Handmade Fango

60x120 - 24"x48" Handmade Fango  
120x280 - 48"x110" Fango Resin Naturale Rettificato



60x120 - 24"x48" Fango Solid Naturale Rettificato - Handmade Fango  
120x280 - 48"x110" Fango Resin Naturale Rettificato / 120x120 - 48"x48" Fango Solid Antislip Rettificato





120x280 - 48"x110" Calce Resin Naturale Rettificato - Fairy Vibes Light Naturale Rettificato (A/B)  
 120x120 - 48"x48" Calce Resin Naturale Rettificato

# Spazi Pubblici

Public Areas  
 Öffentliche Räumlichkeiten  
 Espaces Publics

COLORI / COLOURS

AMBIENTI / AMBIENT

PAGINA / PAGE

Malta Resin / Malta Solid Antislip	Spa	22
Fairy Dark / Beton Resin	Bathroom	24
Beton Resin	Hall	26
Graffiti Dark / Beton Resin	Hall	28
Calce Resin / Handmade Calce	Shop	30
Graffiti Light / Malta Resin	Bedroom	32

## Malta Resin / Malta Solid Antislip

The same range of colours is offered in both finishes, Solid and Resin, so as to enhance and give design to the environments, creating a sensation of harmony and well-being also thanks to the colour combination.

Die gleiche Farbpalette wird in beiden Oberflächen, Solid und Resin, angeboten, um die Räume aufzuwerten und Planungsmöglichkeiten zu bieten, indem ein Gefühl von Harmonie und Wohlbefinden geschaffen wird, das auch durch die Kombinierbarkeit der Farben verstärkt wird.

La même gamme de couleurs est proposée dans les deux finitions, Solid et Resin, pour valoriser et concevoir les espaces, en créant une sensation d'harmonie et de bien-être grâce à l'assortiment des couleurs.

La stessa gamma colori viene proposta in entrambe le finiture, Solid e Resin, così da valorizzare e dare progettualità agli ambienti, creando una sensazione di armonia e benessere grazie anche all'abbinabilità dei colori.

120x280 - 48"x110" Malta Resin Naturale Rettificato  
120x120 - 48"x48" Malta Solid Antislip Rettificato



Cement Vibes  
Public Areas

## Fairy Dark / Beton Resin

With its delicate and romantic design, the Fairy decoration, in the light and dark versions, reproduces a transparent effect through an opaque glass that allows a glimpse of a foliage atmosphere, enriched by hints of gold and platinum.

Mit ihrem zarten und romantischen Design reproduziert die Dekoration Fairy, in den Varianten Light und Dark, einen Transparenzeffekt durch ein mattes Glas, das eine Atmosphäre von Laub erahnen lässt, bereichert durch Akzente aus Gold und Platin.

Avec son design délicat et romantique, le décor Fairy, dans ses variantes claire et foncée, reproduit un effet de transparence à travers un verre opaque qui laisse entrevoir des feuillages, rehaussés par des touches d'or et de platine.

Con il suo design delicato e romantico, il decoro Fairy, nelle varianti light e dark, riproduce un effetto di trasparenza attraverso un vetro opaco che lascia intravedere un'atmosfera di foliage, arricchita da accenni di oro e platino.

120×280 - 48"×110" Fairy Vibes Dark Naturale Rettificato (A/B)  
60×120 - 24"×48" Beton Resin Naturale Rettificato

30×30 - 12"×12" Micromosaico Beton Resin



Cement Vibes  
Public Areas

Beton Resin

120x280 - 48"x110" Beton Resin Naturale Rettificato  
120x120 - 48"x48" Beton Resin Naturale Rettificato



120x120 - 48"x48" Beton Resin Naturale Rettificato



## Graffiti Dark / Beton Resin

The different shades of colors, the variations in texture and the golden tips make this material particularly versatile, allowing you to create unique visual effects.

Die verschiedenen Farbnuancen, die Texturvariationen und die goldenen Spitzen machen dieses Material besonders vielseitig und ermöglichen die Schaffung einzigartiger visueller Effekte.

Les nuances de couleur, les variations de texture et les pointes dorées rendent ce matériau particulièrement polyvalent et permettent de créer des effets visuels uniques.

120×280 - 48"×110" Beton Resin Naturale Rettificato  
120×280 - 48"×110" Graffiti Vibes Dark Naturale Rettificato  
120×120 - 48"×48" Beton Resin Naturale Rettificato

Le sfumature di colore, le variazioni di texture e le punte dorate rendono questo materiale particolarmente versatile, permettendo di creare effetti visivi unici.



Calce Resin / Handmade Calce

120x280 - 48"x110" Calce Resin Naturale Rettificato  
120x120 - 48"x48" Calce Resin Naturale Rettificato



120x280 - 48"x110" Calce Resin Naturale Rettificato  
120x120 - 48"x48" Calce Resin Naturale Rettificato

60x120 - 24"x48" Handmade Calce



# Graffiti Light / Malta Resin

The Graffiti wall decoration, with an eclectic and strong compatibility, offers a modern and industrial touch to any environment.

Die Wanddekoration Graffiti, mit ihrem eklektischen und stark kombinierbaren Stil, bietet jedem Raum einen modernen und industriellen Touch.

Le décor mural éclectique combinable Graffiti apporte une touche moderne et industrielle à toutes les pièces.

THIN  
60x120 6 mm

Il decoro a parete Graffiti, dallo stile eclettico e fortemente abbinabile, offre un tocco moderno e industrial a qualsiasi ambiente.

60x120 - 24"x48" Graffiti Vibes Light Naturale Rettificato ± 6 mm  
60x120 - 24"x48" Malta Resin Naturale Rettificato ± 6 mm

120x120 - 48"x48" Malta Resin Naturale Rettificato



Cement Vibes  
Public Areas

THIN  
60x120 6 mm

## Innovation meets Sustainability

La **riduzione di spessore** segna una svolta decisiva nel mondo del design. Leggerezza e versatilità facilitano l'installazione, rendendo il prodotto idoneo per ogni tipo di progetto.

Questa **soluzione innovativa** rappresenta non solo una scelta all'avanguardia ma anche un impegno verso la sostenibilità, contribuendo a ridurre l'utilizzo di materie prime nel rispetto dell'ambiente.

The reduction of thickness marks a decisive turning point in the world of design. Lightness and versatility facilitate installation, making the product suitable for every type of project. This innovative solution represents not only a cutting-edge choice but also a commitment to sustainability, helping to reduce the use of raw materials while respecting the environment.

Die Reduzierung der Stärke markiert einen entscheidenden Wendepunkt in der Designwelt. Leichtigkeit und Vielseitigkeit erleichtern die Installation und machen das Produkt für jedes Projekt geeignet. Diese innovative Lösung ist nicht nur eine zukunftsweisende Wahl, sondern auch ein Engagement für die Nachhaltigkeit, da sie zur Reduzierung des Einsatzes von Rohstoffen im Einklang mit der Umwelt beiträgt.

La réduction d'épaisseur marque un tournant décisif dans le monde du design. Légèreté et polyvalence facilitent l'installation, rendant le produit adapté à tout type de projet. Cette solution innovante représente non seulement un choix à la pointe, mais aussi un engagement envers la durabilité, contribuant à réduire l'utilisation des matières premières dans le respect de l'environnement.

# Informazioni Tecniche

8

Colori  
Colours  
Farben  
Couleurs

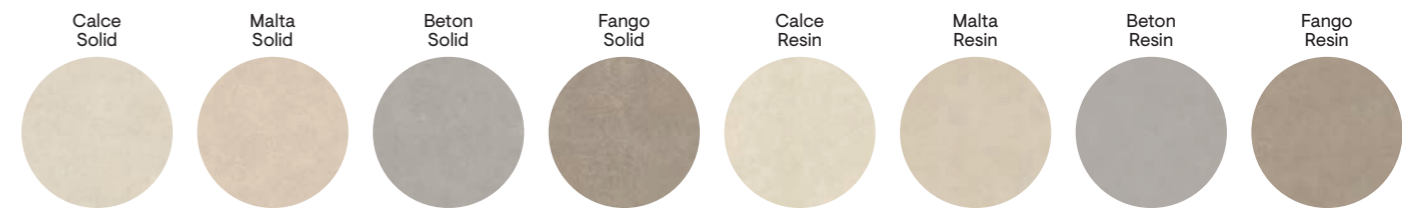

5

Formati  
Sizes  
Formate  
Formats

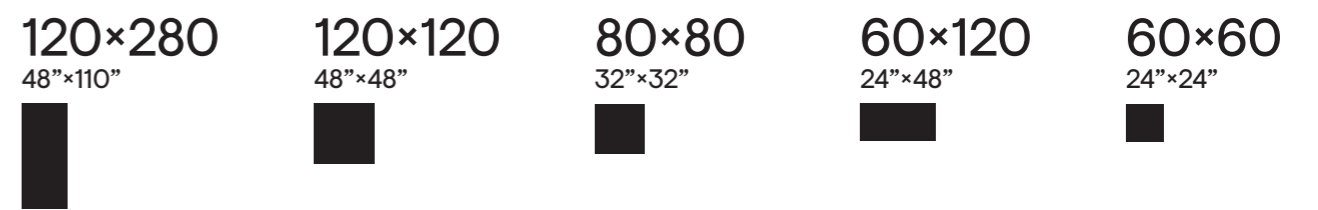

2

Superfici  
Surfaces  
Oberflächen  
Surfaces

Naturale Antislip

1

Strutture 3D  
3D structures  
Strukturen  
Décorations en relief



i

Effetto Cemento  
Cement Look  
Beton Optik  
Effet Béton

Rivestimento  
Wall Tiles  
Wandfliesen  
Revêtement

Pavimento  
Floor Tiles  
Bodenfliesen  
Sol

Gres fine porcellanato ad impasto colorato  
Coloured-body fine porcelain stoneware  
Feinsteinzeug aus farbiger Masse  
Grès cérame fin à pâte colorée

Tecnologia digitale  
Digital technology  
Digital technologie  
Technologie numérique

Ripresa grafica tra le diverse lastre rettificata contenuta entro le tolleranze previste dalla norma. Per un corretto allineamento si consiglia di utilizzare una fuga di 2 mm.  
Graphic representation between the rectified tiles is contained within the tolerances provided by the standard. For a correct alignment it is recommended to use a 2 mm joint.  
Grafische Darstellung zwischen den verschiedenen rektifizierten Platten innerhalb der in der Norm vorgesehenen Toleranzen. Für eine korrekte Anpassung wird eine Fuge von 2mm empfohlen.  
Reproduction graphique entre les différents carreaux rectifiés dans les limites des tolérances prévues par la norme. Pour un alignement correct, il est recommandé d'utiliser joints de 2 mm.

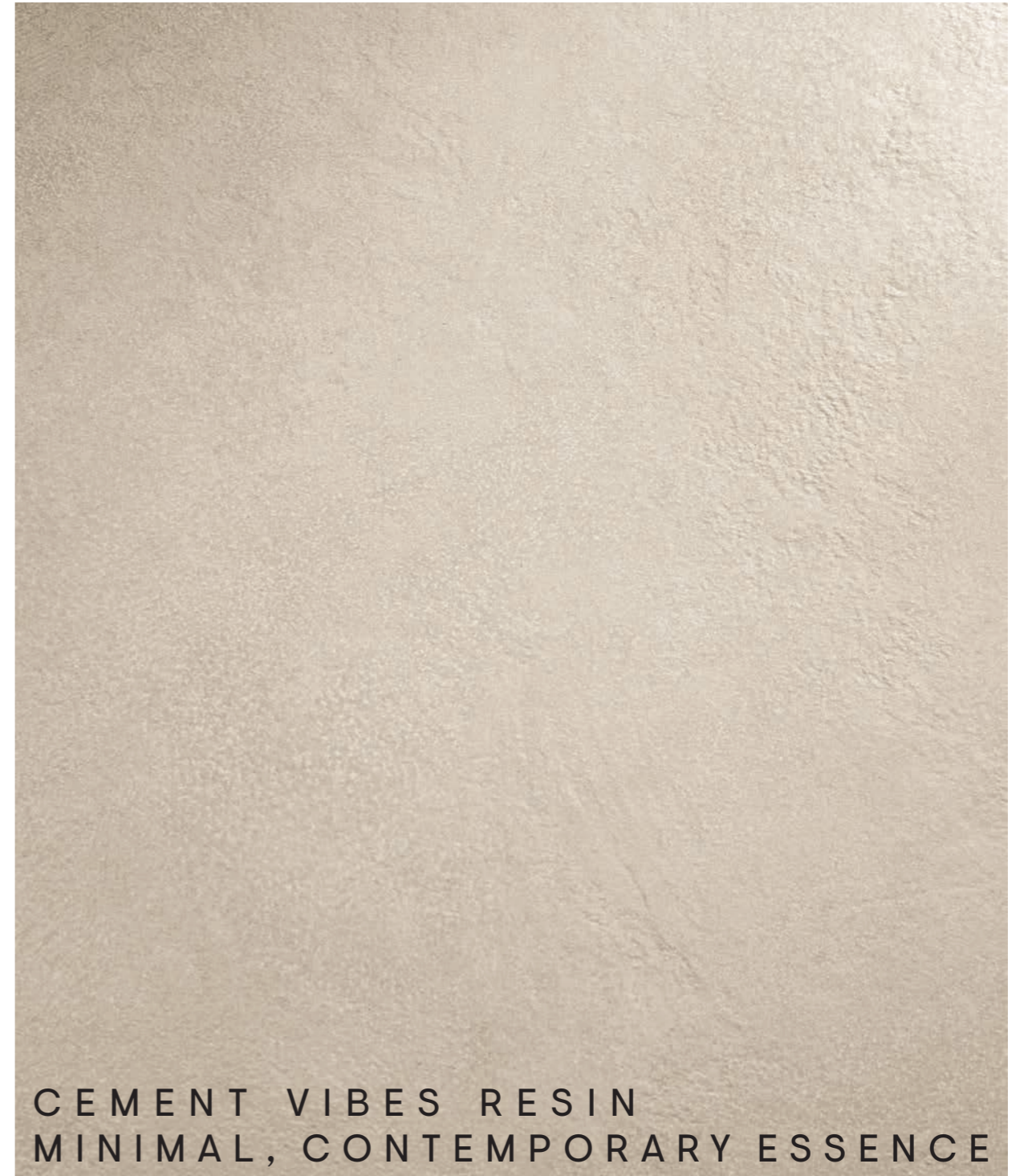

Handmade is a structure that originates from manual craftsmanship, where every detail has been carefully attended to. Every line and every relief are the result of the artist's spontaneous and improvised gestures.

Handmade ist eine Struktur, die aus handwerklicher Arbeit entsteht, bei der jedes Detail mit Sorgfalt gestaltet wurde. Jede Linie und jedes Relief sind das Ergebnis der spontanen und improvisierten Gesten des Künstlers.

Handmade est une structure issue d'un travail manuel dans lequel chaque détail a été soigneusement soigné, chaque ligne et chaque relief sont le résultat du geste spontané et improvisé de l'auteur.



Handmade è una struttura che nasce da una lavorazione manuale in cui ogni dettaglio è stato curato con attenzione, ogni linea e ogni rilievo sono frutto del gesto spontaneo e improvvisato dell'autore.

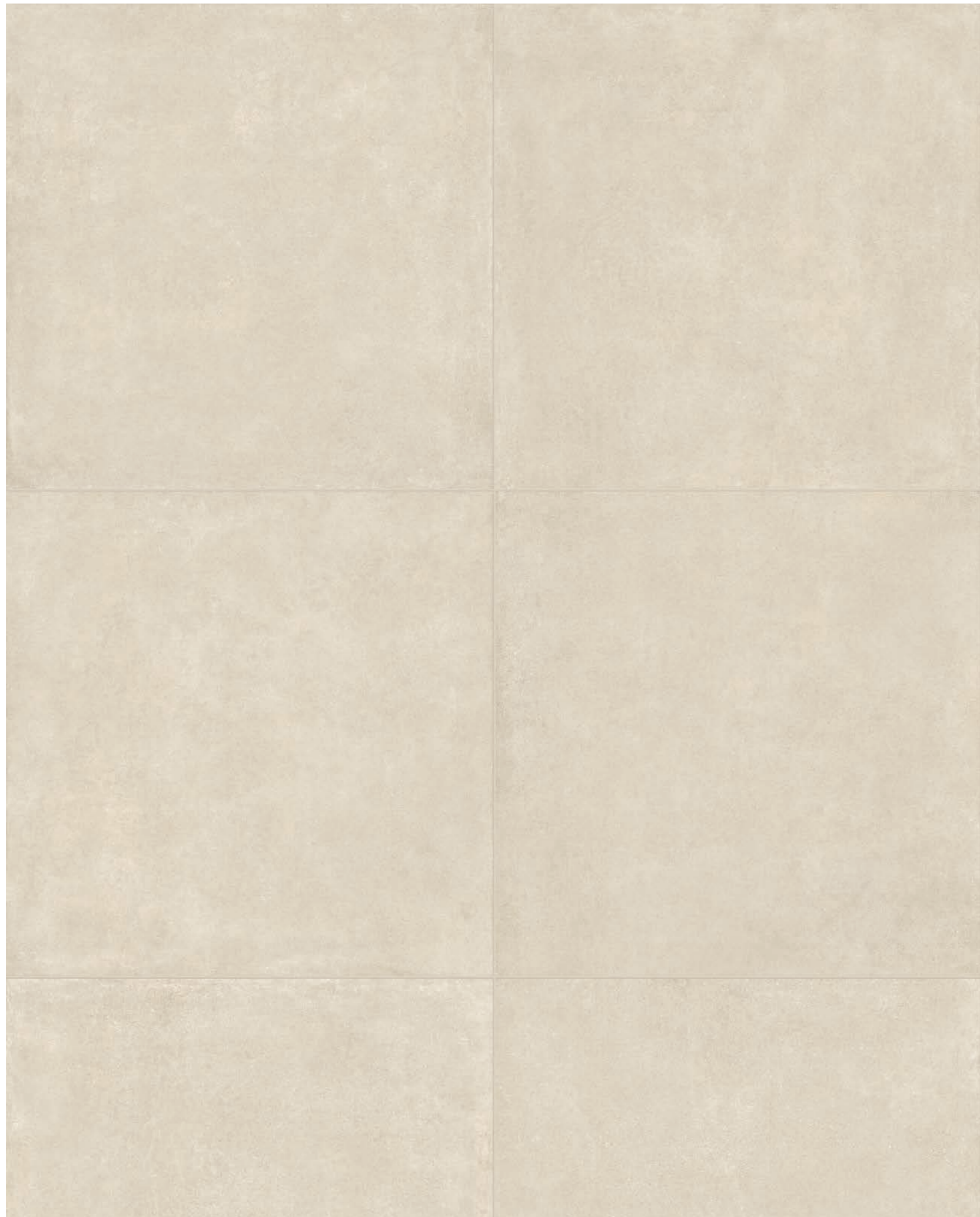

# Calce Solid



± 8,5

INDOOR /  
OUTDOOR  
120x120  
ANTISLIP

120x120 - 48"x48"

05959 | Calce Solid Nat/Ret  
05967 | Calce Solid Antislip/Ret



± 8,5

80x80 - 32"x32"

06156 | Calce Solid Nat/Ret



± 8,5

60x120 - 24"x48"

05951 | Calce Solid Nat/Ret

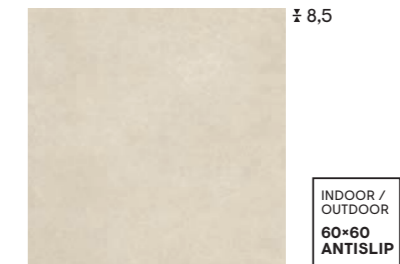

± 8,5

60x60 - 24"x24"

05942 | Calce Solid Nat/Ret  
06152 | Calce Solid Antislip/Ret

INDOOR /  
OUTDOOR  
60x60  
ANTISLIP



± 6

60x120 - 24"x48"

06041A | Graffiti Vibes Light Nat/Ret



± 6

60x120 - 24"x48"

06042A | Graffiti Vibes Dark Nat/Ret

THIN  
60x120 6 mm



± 8,5

60x120 - 24"x48"

05990 | Handmade Vibes Calce Nat/Ret

Pezzi speciali  
Special pieces



Battiscopa 4,5x60 ± 8,5

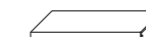

Gradino Costa Retta 33x120 ± 8,5



# Malta Solid



± 8,5

INDOOR /  
OUTDOOR  
120x120  
ANTISLIP

120x120 - 48"x48"

05960 | Malta Solid Nat/Ret  
05968 | Malta Solid Antislip/Ret



± 8,5

80x80 - 32"x32"

06157 | Malta Solid Nat/Ret



± 8,5

60x120 - 24"x48"

05952 | Malta Solid Nat/Ret



± 8,5

60x60 - 24"x24"

05943 | Malta Solid Nat/Ret  
06153 | Malta Solid Antislip/Ret

INDOOR /  
OUTDOOR  
60x60  
ANTISLIP



± 6

60x120 - 24"x48"

06041A | Graffiti Vibes Light Nat/Ret



± 6

60x120 - 24"x48"

06042A | Graffiti Vibes Dark Nat/Ret

THIN  
60x120 6 mm



± 8,5

60x120 - 24"x48"

05991 | Handmade Vibes Malta Nat/Ret

Pezzi speciali  
Special pieces



Battiscopa 4,5x60 ± 8,5

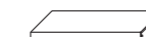

Gradino Costa Retta 33x120 ± 8,5



# Beton Solid



120×120 - 48"×48"  
**05961** | Beton Solid Nat/Ret  
**05969** | Beton Solid Antislip/Ret

INDOOR /  
OUTDOOR  
120×120  
ANTISLIP



80×80 - 32"×32"  
**06158** | Beton Solid Nat/Ret



60×120 - 24"×48"  
**05953** | Beton Solid Nat/Ret



60×60 - 24"×24"  
**05944** | Beton Solid Nat/Ret  
**06154** | Beton Solid Antislip/Ret

INDOOR /  
OUTDOOR  
60×60  
ANTISLIP



60×120 - 24"×48"  
**06041A** | Graffiti Vibes Light Nat/Ret



60×120 - 24"×48"  
**06042A** | Graffiti Vibes Dark Nat/Ret

THIN  
60×120 6 mm



60×120 - 24"×48"  
**05992** | Handmade Vibes Beton Nat/Ret

Pezzi speciali  
Special pieces



Battiscopa 4,5×60 ± 8,5

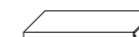

Gradino Costa Retta 33×120 ± 8,5



# Fango Solid



± 8,5

INDOOR /  
OUTDOOR  
120x120  
ANTISLIP

120x120 - 48"x48"

05962 | Fango Solid Nat/Ret  
05970 | Fango Solid Antislip/Ret



± 8,5

80x80 - 32"x32"

06159 | Fango Solid Nat/Ret



± 8,5

60x120 - 24"x48"

05954 | Fango Solid Nat/Ret



± 8,5

60x60 - 24"x24"

05945 | Fango Solid Nat/Ret  
06155 | Fango Solid Antislip/Ret

INDOOR /  
OUTDOOR  
60x60  
ANTISLIP



± 6

60x120 - 24"x48"

06041A | Graffiti Vibes Light Nat/Ret



± 6

60x120 - 24"x48"

06042A | Graffiti Vibes Dark Nat/Ret

THIN  
60x120 6 mm



± 8,5

60x120 - 24"x48"

05993 | Handmade Vibes Fango Nat/Ret

Pezzi speciali  
Special pieces



Battiscopa 4,5x60 ± 8,5

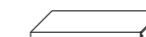

Gradino Costa Retta 33x120 ± 8,5



# Calce Resin



120×280  
05971 | Calce Resin Nat/Ret



120×120 - 48"×48"  
05963 | Calce Resin Nat/Ret



80×80 - 32"×32"  
06160 | Calce Resin Nat/Ret



60×120 - 24"×48"  
05955 | Calce Resin Nat/Ret  
06037 | Calce Resin Nat/Ret\*



60×60 - 24"×24"  
05947 | Calce Resin Nat/Ret

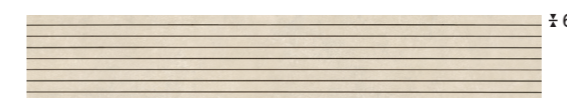

20×120 - 8"×48"  
06043 | Calce Resin Cannelé Nat/Ret



30×30 - 12"×12"  
06047 | Micromosaico Calce Resin Nat/Ret

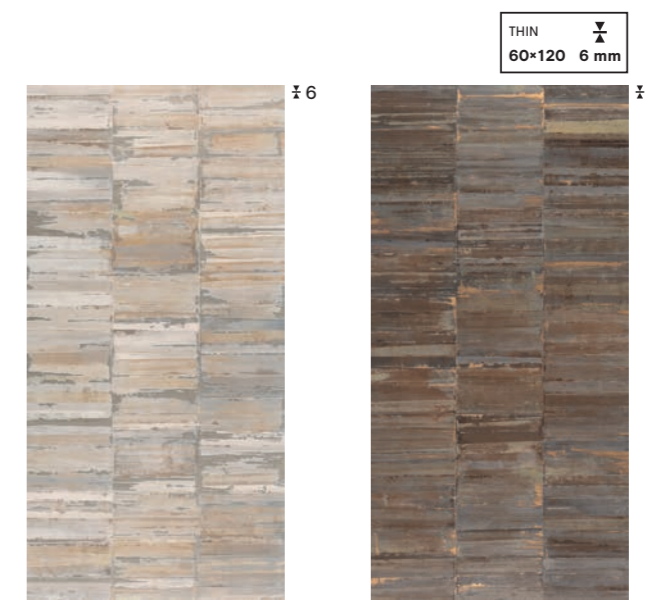

60×120 - 24"×48"  
06041A | Graffiti Vibes Light Nat/Ret

60×120 - 24"×48"  
06042A | Graffiti Vibes Dark Nat/Ret

60×120 - 24"×48"  
05990 | Handmade Vibes Calce Nat/Ret

Pezzi speciali  
Special pieces



Battiscopa 4,5×60 ± 8,5

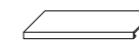

Gradino Costa Retta 33×120 ± 8,5

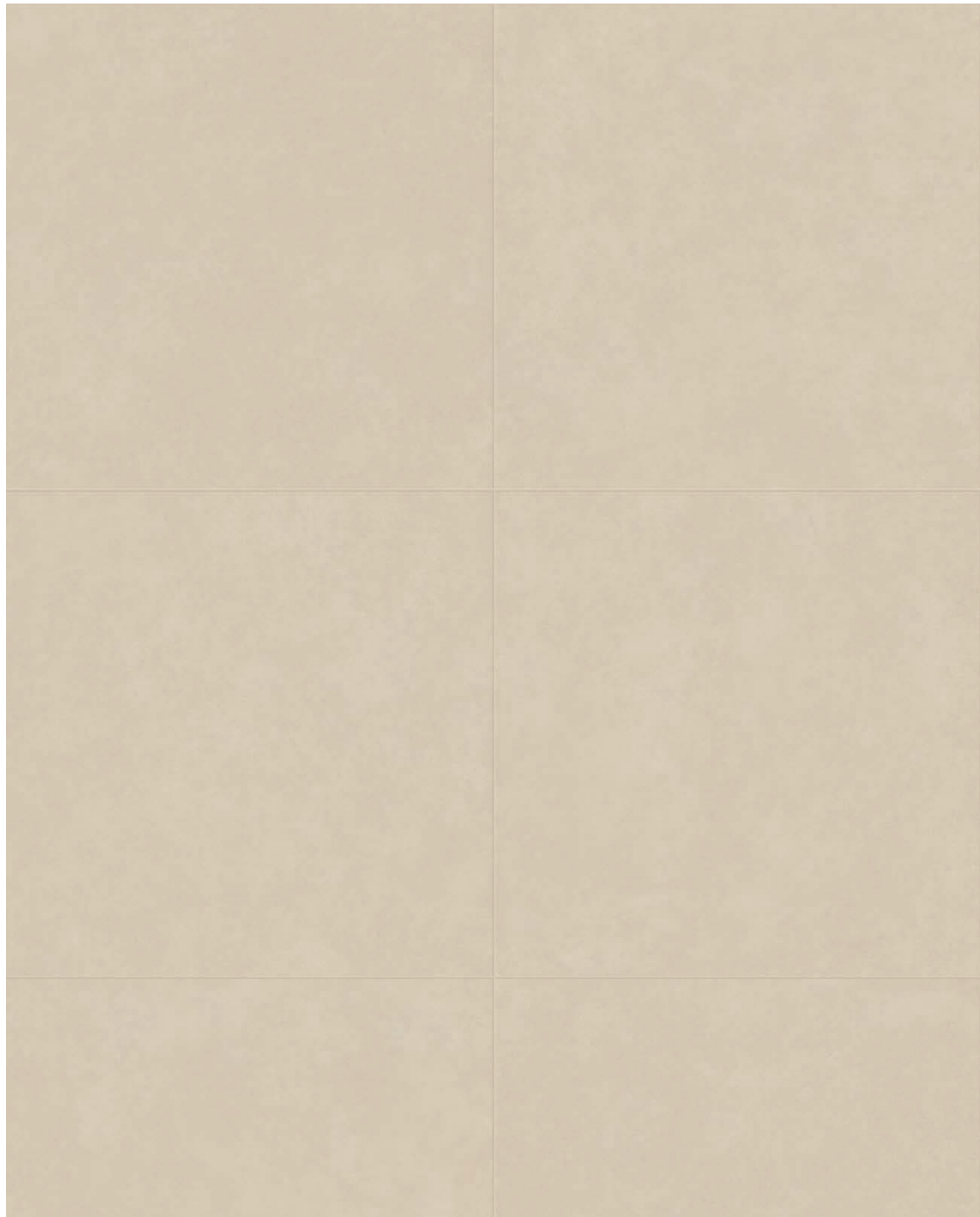

# Malta Resin



± 6

120×280

05972 | Malta Resin Nat/Ret

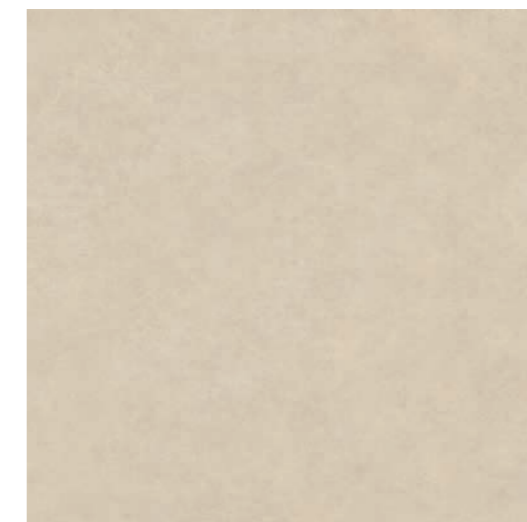

± 8,5

120×120 - 48"×48"

05964 | Malta Resin Nat/Ret

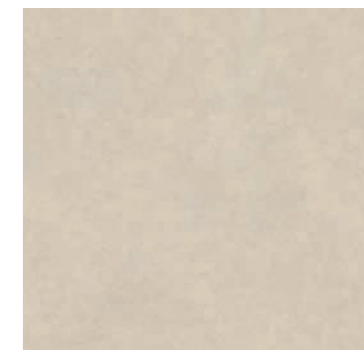

± 8,5

80×80 - 32"×32"

06161 | Malta Resin Nat/Ret



THIN  
60×120 6 mm

± 8,5

± 6\*

60×120 - 24"×48"

05956 | Malta Resin Nat/Ret  
06038 | Malta Resin Nat/Ret\*



± 8,5

60×60 - 24"×24"

05948 | Malta Resin Nat/Ret



± 6

60×120 - 24"×48"

06041A | Graffiti Vibes Light Nat/Ret



± 6

60×120 - 24"×48"

06042A | Graffiti Vibes Dark Nat/Ret



± 8,5

60×120 - 24"×48"

05991 | Handmade Vibes Malta Nat/Ret

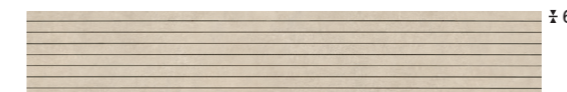

± 6

20×120 - 8"×48"

06044 | Malta Resin Cannelé Nat/Ret



± 8,5

30×30 - 12"×12"

06048 | Micromosaico Malta Resin Nat/Ret

Pezzi speciali  
Special pieces



Battiscopa 4,5×60 ± 8,5

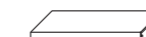

Gradino Costa Retta 33×120 ± 8,5

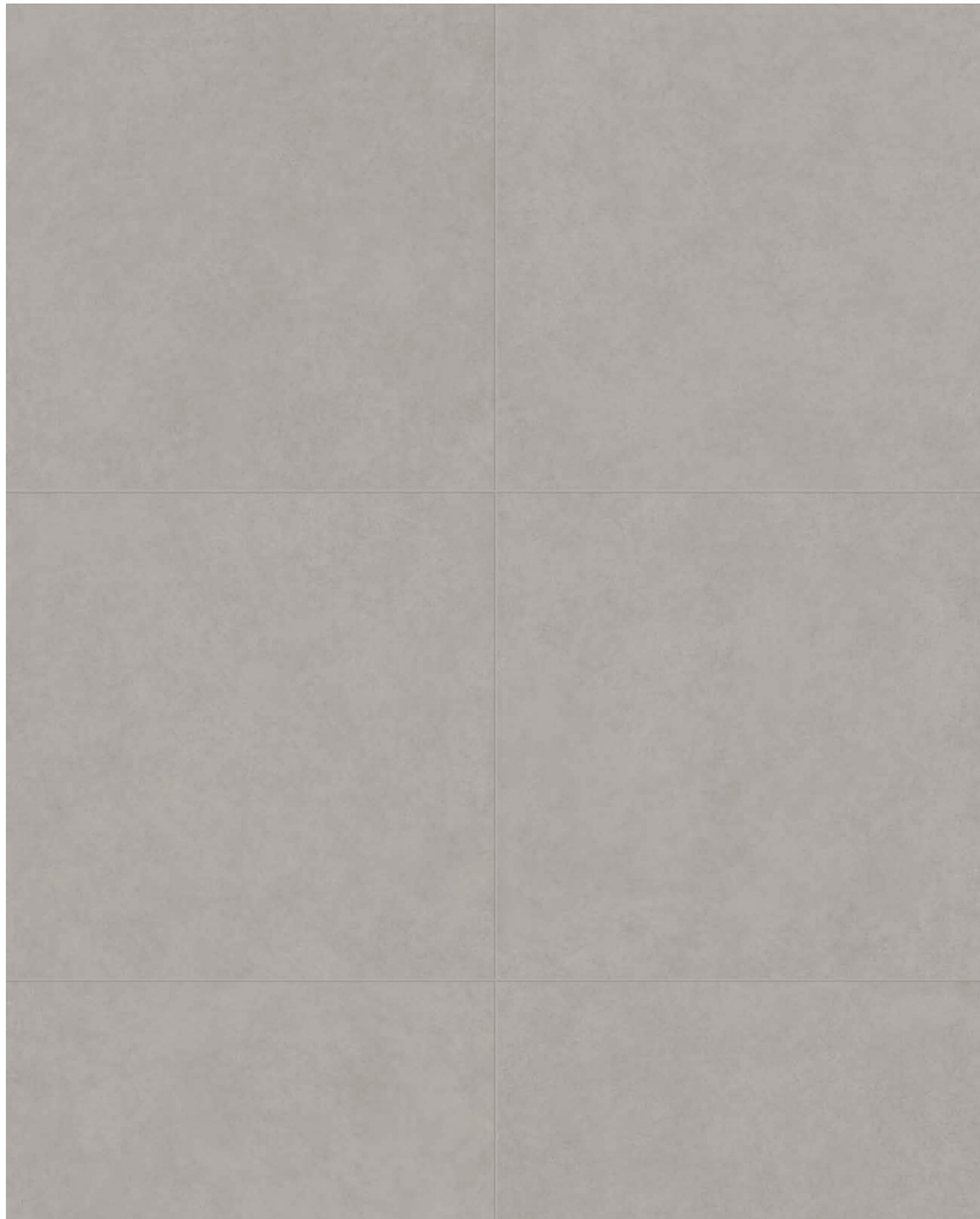

# Beton Resin



± 6

120×280  
05973 | Beton Resin Nat/Ret

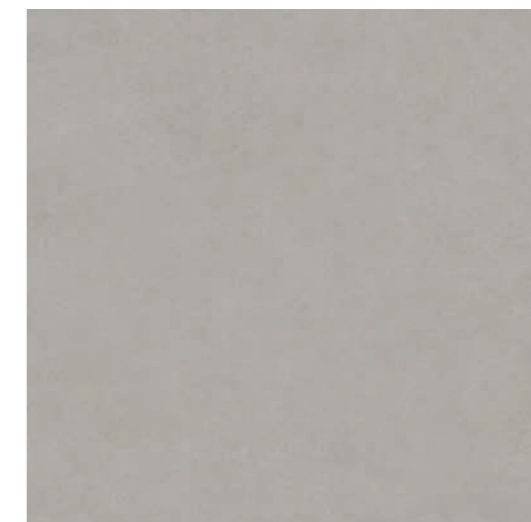

± 8,5

120×120 - 48"×48"  
05965 | Beton Resin Nat/Ret

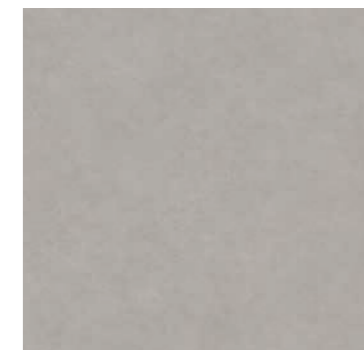

± 8,5

80×80 - 32"×32"  
06162 | Beton Resin Nat/Ret

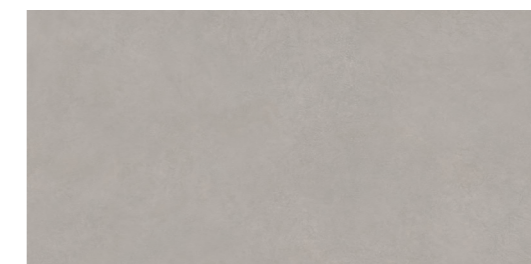

THIN  
60×120 6 mm

± 8,5

± 6\*

60×120 - 24"×48"  
05957 | Beton Resin Nat/Ret  
06039 | Beton Resin Nat/Ret\*



± 8,5

60×60 - 24"×24"  
05949 | Beton Resin Nat/Ret

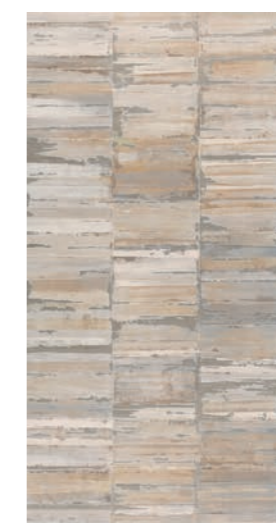

± 6

60×120 - 24"×48"  
06041A | Graffiti Vibes Light Nat/Ret



± 6

60×120 - 24"×48"  
06042A | Graffiti Vibes Dark Nat/Ret



± 8,5

60×120 - 24"×48"  
05992 | Handmade Vibes Beton Nat/Ret



± 6

20×120 - 8"×48"  
06045 | Beton Resin Cannelé Nat/Ret

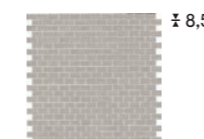

± 8,5

30×30 - 12"×12"  
06049 | Micromosaico Beton Resin Nat/Ret

Pezzi speciali  
Special pieces



Battiscopa 4,5×60 ± 8,5

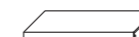

Gradino Costa Retta 33×120 ± 8,5



# Fango Resin



± 6

120×280  
**05974** | Fango Resin Nat/Ret



± 8,5

120×120 - 48"×48"  
**05966** | Fango Resin Nat/Ret



± 8,5

80×80 - 32"×32"  
**06163** | Fango Resin Nat/Ret



THIN  
60×120 6 mm

± 8,5

± 6\*

60×120 - 24"×48"  
**05958** | Fango Resin Nat/Ret  
**06040** | Fango Resin Nat/Ret\*



± 8,5

60×60 - 24"×24"  
**05950** | Fango Resin Nat/Ret



THIN  
60×120 6 mm

± 8,5

± 6

60×120 - 24"×48"  
**06041A** | Graffiti Vibes Light Nat/Ret



± 8,5

60×120 - 24"×48"  
**06042A** | Graffiti Vibes Dark Nat/Ret  
**05993** | Handmade Vibes Fango Nat/Ret

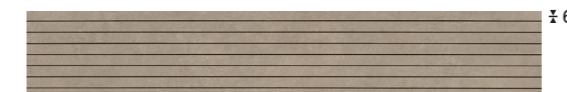

± 6

20×120 - 8"×48"  
**06046** | Fango Resin Cannelé Nat/Ret



± 8,5

30×30 - 12"×12"  
**06050** | Micromosaico Fango Resin Nat/Ret

Pezzi speciali  
Special pieces



Battiscopa 4,5×60 ± 8,5

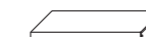

Gradino Costa Retta 33×120 ± 8,5

Decors  
Dekorationen  
Décorations



120x280  
06051 | Fairy Vibes Light A Nat/Ret

120x280  
06052 | Fairy Vibes Light B Nat/Ret



120x280  
06053 | Fairy Vibes Dark A Nat/Ret

120x280  
06054 | Fairy Vibes Dark B Nat/Ret

Decors  
Dekorationen  
Décorations



±6

120x280  
06055 | Graffiti Vibes Light Nat/Ret

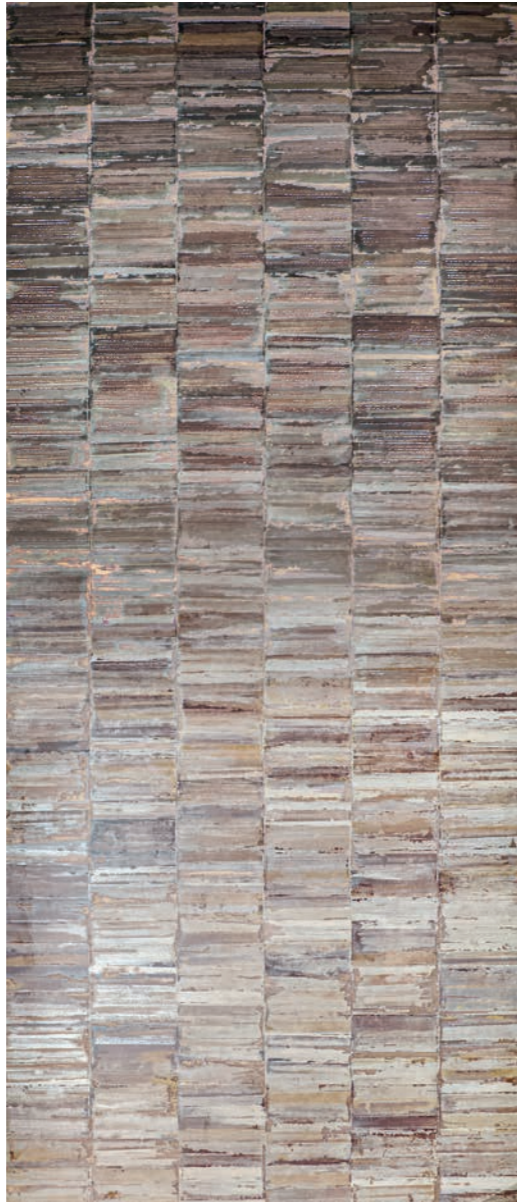

±6

120x280  
06056 | Graffiti Vibes Dark Nat/Ret

Special pieces  
Formstücke  
Pièces spéciales

Battiscopa Nat/Ret 4,5x60 – 1 1/4"x24" ± 8,5

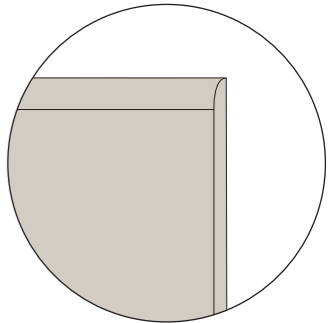

Gradino Costa Retta Nat/Ret 33x120 – 13"x48" ± 8,5  
(costa retta ottenuto per taglio e incollaggio - obtained by cutting and gluing)

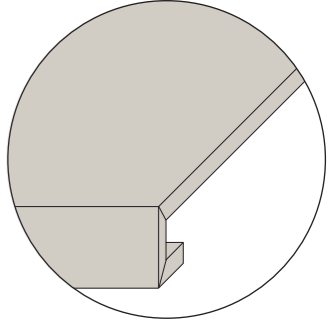



Formati Sizes	MM								
	MM	Pezzi Scatola Pieces/Box Stck/Karton Carreaux/Boîte	Mq/Scatola Sqmt/Box Qm/Karton M2/Boîte	Kg/Scatola Kgs/Box Kg/Karton Kg/Boîte	Scatole/Paletta Boxes/Pallet Karton/Palette Boîte/Palette	Mq/Paletta Sqmt/Pallet Qm/Pallet M2/Palette	Kg/Paletta Kgs/Pallet Kg/Pallet Kg/Palette	Formato Paletta Size Pallet Format Pallet Dim. Palette	
120x280 (48"x110") Nat/Ret	P	6	1	3,36	46,50	20	67,20	930	143x294x35
120x120 (48"x48") Nat/Ret - Antislip/Ret	P	8,5	2	2,88	55,00	24	69,12	1320	135x122x68
80x80 (32"x32") Nat/Ret	P	8,5	2	1,28	24,50	54	69,12	1323	124x80x96
60x120 (24"x48") Nat/Ret	P	8,5	2	1,44	28,00	44	63,36	1232	122x100x75
60x120 (24"x48") Nat/Ret	P	6	3	2,16	29,50	36	77,76	1062	122x95x75
60x60 (24"x24") Nat/Ret - Antislip/Ret	P	8,5	4	1,44	26,00	40	57,6	1040	120x80x75
120x280 (48"x110") Fairy Nat/Ret	P	6	1	3,36	46,50	20	67,20	930	143x294x35
120x280 (48"x110") Graffiti Vibes Nat/Ret	P	6	1	3,36	46,50	20	67,20	930	143x294x35
60x120 (24"x48") Handmade Nat/Ret	P	8,5	2	1,44	28,00	44	63,36	1232	122x100x75
60x120 (24"x48") Graffiti Nat/Ret	P	6	3	2,16	29,50	36	77,76	1062	122x95x75
20x120 (8"x48") Canneté Resin Nat/Ret	P	6	6	1,44	19,00	36	-	-	-
30x30 (12"x12") Micromosaico Resin Nat/Ret	P	8,5	7	0,63	12,00	60	-	-	-

Pezzi Speciali / Special Pieces

33x120 (13"x48") Gradino Costa Retta Nat/Ret	P	8,5	2	0,79	15,60	20	-	-	-
4,5x60 (1 1/2"x24") Battiscopa Nat/Ret - Lap/Ret	P	8,5	14	0,38 m.l. 8,40	8,00	80	-	-	-

CLASSIFICAZIONE SECONDO NORME EN 14411 BI<sub>A</sub> - ISO 13006 - CLASSIFICATION IN ACCORDANCE WITH EN 14411 BI<sub>A</sub> - ISO 13006  
KLASSIFIZIERUNG GEMÄSS NORMEN EN 14411 BI<sub>A</sub> - ISO 13006 - CLASSIFICATION SELON LES NORMES EN 14411 BI<sub>A</sub> - ISO 13006

Dimensioni nominali (cm x cm): Nominal sizes (cm x cm):	consultare catalogo consult catalogue	Spessore (mm) / Thickness (mm): Gruppo prodotto / Product Group: Allegato G - B <sub>IA</sub> - UGL / Annex G - B <sub>IA</sub> - UGL
--	--	--

Caratteristica tecnica Technical characteristic	Metodo di prova Test method	Requisito per le dimensioni nominali N ≥ 15 cm Requirement for nominal size N ≥ 15 cm	Valore medio Mean value <b>CERAMICHEPIEMME</b> FLOOR AND MORE
--	--------------------------------	--	--

Lunghezza e larghezza / Length and width	ISO 10545-2	± 0,6 % (max ± 2,00 mm) Rett./Rect.: ± 0,3 % (max ± 1,00 mm)	<b>Conforme</b> In accordance
Spessore / Thickness		± 5 % (max ± 0,50 mm)	
Rettilinearità dei lati / Straightness of sides		± 0,5 % (max ± 1,50 mm) Rett./Rect.: ± 0,3 % (max ± 0,80 mm)	
Ortogonalità / Rectangularity		± 0,5 % (max ± 2,00 mm) Rett./Rect.: ± 0,3 % (max ± 1,50 mm)	
Planarità superficie / Surface flatness		± 0,5 % (max ± 2,00 mm) Rett./Rect.: ± 0,4 % (max ± 1,80 mm)	
Assorbimento acqua / Water absorption Water absorption (%)	ISO 10545-3	Ev ≤ 0,5 %	Ev ≤ 0,1 %
Sforzo di rottura (S) Breaking strenght (S)	ISO 10545-4	S > 1300 N (Spessore / Thickness ≥ 7,5 mm) S > 700 N (Spessore / Thickness < 7,5 mm)	<b>Conforme / In Accordance</b> (S > 12000 N (Spessore/Thickness = 20 mm))
Resistenza alla flessione Modulus of rupture		R > 35 N/mm <sup>2</sup> (Medio/Average)	R > 45 N/mm <sup>2</sup> (Medio/Average)
Resistenza all'urto Impact resistance	ISO 10545-5	COR > 0,55 (Coeff. restituzione) COR > 0,55 (Coeff. restitution)	<b>Conforme</b> In accordance
Resistenza all'abrasione profonda Resistance to deep abrasion	ISO 10545-6	< 175 mm <sup>3</sup>	< 140 mm <sup>3</sup>
Coeff. Dilatazione termica lineare 20-100°C Coeff. Linear thermal expansion	ISO 10545-8	Valore dichiarato Declared value	6,7x10 <sup>-6</sup> °C <sup>-1</sup>
Resistenza agli sbalzi termici Thermal shock resistance	ISO 10545-9	Prova superata Test passed	<b>Resistente</b> Resistant
Resistenza al gelo Frost resistance	ISO 10545-12	Prova superata Test passed	<b>Resistente</b> Resistant
Resistenza ai prodotti chimici acidi e basi a basse concentrazioni/alte concentrazioni prodotti chimici d'uso domestico e additivi per piscina Resistance to chemicals low/high concentrations of acids and alkalis household chemicals and swimming pool salts	ISO 10545-13	Valore dichiarato Minimo Classe B  Declared value Minimum Class B	<b>NAT - ANTISLIP</b>  LA A  LA A
Resistenza alle macchie Resistance to staining	ISO 10545-14	Minimo Classe 3 / Valore dichiarato Minimum Class 3 / Declared value	<b>NAT - ANTISLIP</b> 5
Resistenza allo scivolamento * Slip Resistance	EN 16165 C (ex Din 51130) EN 16165 A (ex Din 51097) ANSI A326.3:2022 (DCOF) D.M.236/89 (B.C.R.A.) BS EN 16165:2021 Annex C AS/NZS 4586-13 Annex A	Valore dichiarato / Declared Value	<b>NAT</b> R10
		Valore dichiarato / Declared Value	<b>ANTISLIP</b> R11
		Valore dichiarato / Declared Value	A+B
		μ > 0,4 (Wet / Dry)	A+B+C
		PTV > 36 (low slip risk)	Wet DCOF>0,42
Declarated classification			
Conduttività termica Thermal conductivity	UNI EN 12524	/	λ = 1,3 W / m <sup>2</sup> K
Variazione dei colori alla luce Light and colour fastness	DIN 51094	/	<b>Nessuna variazione / No variations</b>
Reazione al fuoco Fire reaction	UNI EN 13501-1	/	A1 <sub>FL</sub> (Classe / Class)

ELENCO DELLE SERIE CERTIFICATE E CLASSIFICAZIONI DISPONIBILI A RICHIESTA - LIST OF CERTIFIED SERIES AND CLASSIFICATIONS AVAILABLE UPON REQUEST  
LISTE DER GEPRÜFTEN SERIE UND KLASSIFIZIERUNGEN AUF ANFRAGE ERHÄLTlich - LISTE DES SERIES CERTIFIÉES ET DES CLASSEMENTS DISPONIBLES SUR DEMANDE

\* Trattandosi di normative nazionali, i metodi di prova, i requisiti e le classificazioni variano da paese a paese. Il valore atteso della resistenza allo scivolamento della produzione di Industrie Ceramiche Piemme SpA può variare in base al lotto produttivo. Specifica documentazione è disponibile su richiesta.  
\* Test methods, requirements and classifications differ from country to country, according to the national regulations. The expected value of the slip resistance of Industrie Ceramiche Piemme SpA production may vary depending on the production batch. Specific documents are available upon request.

\* Les méthodes d'essai, les réquisitions et les classifications changent de pays à pays, selon les réglementations nationales. La valeur attendue de la résistance au glissement de la production d'Industrie Ceramiche Piemme SpA peut varier en fonction du lot de production. Des documents spécifiques sont disponibles sur demande.

\* Prüfmethoden, Anforderungen und Klassifizierungen unterscheiden sich je nach landesspezifischen Vorschriften von Land zu Land. Der erwartete Wert der Rutschfestigkeit der Produktion von Industrie Ceramiche Piemme SpA kann je nach Produktionscharge variieren. Spezifische Dokumente sind auf Anfrage erhältlich.



# Norme per la posa e la manutenzione

## Installation and maintenance instructions

### Verlegung, reiningung und pflege

#### Guide a la pose et l'entretien

- Per i prodotti rettificati consigliamo una fuga di 2 mm per un migliore risultato di posa.

- Per una migliore resa estetica Piemme consiglia stuccature colorate in tinta con le piastrelle. Verificare, prima dell'utilizzo, la compatibilità ed idoneità dei riempitivi per fughe con il prodotto ceramico.

- Rimuovere le eccedenze dei riempitivi per fughe quando gli stessi sono ancora freschi.

- Attenersi scrupolosamente alle istruzioni indicate dai produttori dei riempitivi per fughe.

- Per eliminare completamente i residui di posa, che potrebbero compromettere la manutenzione ordinaria e le caratteristiche del prodotto, a posa ultimata, procedere con la pulizia utilizzando prodotti adeguati, a base Acida max 3%, rispettando le indicazioni del produttore. Osservare assolutamente i limiti di tempo indicati nelle istruzioni: un contatto troppo pro lungato con questi prodotti potrebbe provocare il danneggiamento della superficie.

- Gli eventuali aloni che si dovessero presentare dopo la posa di materiali lappati o levigati si potranno facilmente eliminare utilizzando un prodotto idoneo, a base Alcalina.

- Riguardo l'utilizzo di materiali ceramici all'esterno, pure riconfermando l'ingelività dei prodotti Piemme in gres porcellanato, in conformità alle vigenti normative europee EN 14411/ISO 13006-ISO 10545.12, occorre attenersi ad alcune fondamentali norme previste per la posa all'esterno, atte a rendere inattaccabili al gelo i predetti pavimenti. Le condizioni più importanti da rispettare sono: le opportune pendenze, le impermeabilizzazioni, i giunti di dilatazione, e l'uso di idonei materiali per la posa.

- Decorì realizzati con smalti e metalli preziosi è indispensabile proteggere la superficie durante la posa, non utilizzare assolutamente prodotti abrasivi e/o acidi, ma solo acqua e sapone neutro. Il produttore non risponde di eventuali danni a questi preziosi materiali causati da "sfregamenti" durante la posa in opera. Per nessun motivo saranno accettate contestazioni relative a materialeposato.

TIPO DI SPORCO	INDICAZIONI PER LA PULIZIA
Birra, Caffè, Gelato, Vino Gomma Pneumatico, Grassi vegetali e animali, Inchiostri, Lampostil Olii Meccanici, Residui di scotch Olio di lino, PennarelloResine Smalti, Tintura per capelli	Prodotti a Base Alcalina
Cera protettiva anti-abrasione, Depositi calcarei, Macchie di ruggine	Prodotti a Base Acida
Cera di candela, Residui di scotch	Solventi
Per ulteriori informazioni specifiche consultare l'area tecnica sul sito Piemme: <a href="http://www.ceramichepiemme.it">www.ceramichepiemme.it</a>	

TYPE OF STAIN	CLEANING SUGGESTIONS
beer, coffee, wine, ice cream vegetable and animal fats, rubber, remains of scotch tape, grease from machines, linseed oil, felt tip pens, paints, inks, hair dye	Alkaline-based detergent
protective anti-abrasion wax, calcareous residuals, rust stains	Acid-based detergent
candle wax, remains of scotch-tape	Solvents
For further specific details please visit the technical area on Piemme website: <a href="http://www.ceramichepiemme.it">www.ceramichepiemme.it</a>	

- Damit sich eine bessere Verlegung von geschliffenen Produkten ergibt, empfehlen wir eine Fugenbreite von 2 mm.Für ein optisch perfektes Ergebnis empfiehlt Piemme, die Fugen farblich auf die Fliesen abzustimmen.

- Prüfen sie bitte, vor der Verwendung, die Zweckmäßigkeit und die Verträglichkeit des Fugenfüllmittels mit den Keramikfliesen.

- Bitte entfernen sie das überflüssige Fugenfüllmittel wenn es noch frisch ist.

- Folgen sie bitte sorgfältig die von dem Herstellern des Fugenfüllmittels angegebenen Bedienungsvorschriften.

- Zur vollkommenen Entfernung der Verlegerückstände, die die normale Pflege erschweren und die Merkmale des Produkts beeinträchtigen könnten, nach der Verlegung geeignete Reinigungsmittel auf max. 3% Säurebasis verwenden und bei der Reinigung die Hinweise des Herstellers beachten. Die angegebenen Zeiten keinesfalls überschreiten: ein zu lange andauernder Kontakt mit diesen Produkten kann Beschädigungen der Oberfläche verursachen.

- Eventuelle nach der Verlegung von geläppter oder geschliffenem Material sichtbare Schleier lassen sich einfach mit entsprechenden, alkalischen Produkten entfernen.

- Auch wenn die Piemme-Feinsteinzeugprodukte gemäß den europäischen Normen EN 14411/ISO 13006-ISO 10545.12 frostbeständig sind, müssen beim Einsatz keramischer Materialien im Freien einige Grundregeln beachtet werden, damit die Bodenbeläge nicht vom Frost angegriffen werden können. Die wichtigsten Voraussetzungen sind: korrektes Gefälle, Abdichtung, Dehnungsfugen sowie geeignetes Verlegematerial.

- Dekore mit Glasuren und Edelmetallen Während der Verlegung muss die Oberfläche unbedingt abgedeckt werden. Es dürfen keine scheuernden und/oder säurehaltigen Produkte verwendet werden, sondern ausschließlich Wasser und neutrale Seife. Der Hersteller haftet nicht für eventuelle, während der Verlegung durch Abrieb entstandene Schäden an diesen hochwertigen Materialien. Reklamationen von bereits verlegtem Material werden in keinem Fall akzeptiert.

VERSCHMUTZUNGSART	REINIGUNGSHINWEISE
Bier, Wein, Eis, Kaffee Tierische oder pflanzliche Fette Gummi, Kleberbandresten Schmieröl, Tinte, Leöl, Filzstift, Harz oder Lack, Haarfarbe	Alakalische Reinigungsmittel
Kratzenschutz-Wachs, Kalkablagerunge, Rostflecken	Säure-Reinigungsmittel
Kerzenwachs Kleberbandresten	Lösungsmittel
Weitere Einzelheiten finden Sie in dem technischen Bereich des Piemme website: <a href="http://www.ceramichepiemme.it">www.ceramichepiemme.it</a>	

- Pour obtenir le meilleur résultat de pose de produits rectifiés, il est conseillé de réaliser un joint de 2 mm.

- Pour parfaire l'effet esthétique obtenu, Piemme conseille de confectionner des joints de la même couleur que les carreaux.

- Vérifier avant la pose la compatibilité et convenance des remplissages pour joints avec le produit céramique.

- Enlever les surplus des remplissages pour joints alors qu'ils sont encore frais.

- Respecter scrupuleusement les instructions indiquées par les fabricants de remplissages pour joints.

- Pour éliminer complètement tout résidu de pose pouvant gêner l'entretien courant et altérer les caractéristiques du produit, il est conseillé, à la fin de la pose, de procéder au nettoyage du carrelage avec des produits à base acide maximum 3% et de respecter les consignes du fabricant. Suivre impérativement les délais indiqués dans la notice car le contact trop prolongé de ces produits pourrait endommager la surface.

- Pour éliminer facilement la présence éventuelle de cernes après la pose de carreaux rodés ou polis, utiliser un produit à base alcaline.

- Pour ce qui est de la pose à l'extérieur, bien que les produits Piemme en grès cérame soient ingélifs, conformément aux normes européennes EN 14411/ISO 13006-ISO 10545.12, il convient cependant de respecter quelques règles fondamentales de manière à rendre le carrelage inattaquable au gel. Les conditions les plus importantes à remplir sont: le degré d'inclinaison, l'imperméabilisation, les joints de dilatation et l'utilisation de matériaux de pose appropriés.

- Décors réalisés avec des émaux et des métaux précieux Il est indispensable de protéger la surface pendant la pose. N'utiliser en aucun cas des produits abrasifs et/ou acides mais uniquement de l'eau et du savon neutre. La fabricant ne répond pas des dommages éventuels de ces matériaux précieux causés par le frottement pendant la pose. Aucune réclamation, quelle qu'elle soit, concernant le matériau posé ne sera acceptée.

TYPE DE TACHE	NETTOYAGE CONSEIL
Bière, Vin, Glace, Café, Graisses végétales et animales, Encres, Résidus de scotch, Huile de graissage, Hile de lin Crayon feutre Émaux, Teinture pour cheveux, Caoutchouc pour pneus	Détergents à base alcaline
Cire de protection anti abrasion, Dépôts de calcaire, Tache de rouille	Détergents à base d'acide
Cire de bougie Résidus de scotch	Solvant
Pour d'ultérieures Information spécifiques consulter le département technique du site Piemme: <a href="http://www.ceramichepiemme.it">www.ceramichepiemme.it</a>	

# Guida alla Lettura

## Reading Guide

### Leseanleitung

#### Guide à la lecture

▼  
▲  
Spessore  
Thickness  
Stärke  
Épaisseur

Variazione nelle sfumature di colore  
Color shade variations  
Variation der Farbnuancen  
Variation des nuances de couleur

Resistenza alla scivolosità  
Skid resistance  
Rutschfestigkeit  
Resistance au glissement

DIN 51130	DIN 51097	DCOF
R10	A+B	>0,42

V1

Aspetto uniforme  
Uniform apperance  
Gleichförmiges aussehen  
Aspect uniforme

V2

Variazione leggera  
Slight variation  
Leichte variation  
Variation légère

V3

Variazione moderata  
Moderate variation  
Mäßige variation  
Variation modeste

V4

Variazione casuale  
Random variation  
Zufällige variation  
Variation fortuite

Tutti i formati sono nominali.

All sizes are nominal.

Die Formate sind Nennwerte.

Tous les formats sont nominaux.

Gli spessori riportati in questo catalogo sono nominali e possono variare a seconda dei formati e delle finiture.

The thickness mentioned on this catalogue are nominal and can be different according to the sizes and the finishes.

Die in diesem Katalog angegebenen Fliesenstärke sind nominal und können, je nach Format oder Oberfläche, verschieden sein.

Les épaisseurs reportées sur ce catalogue sont nominales et peuvent varier suivant les formats et les finitions.

I colori e le caratteristiche estetiche dei prodotti sono quanto più possibile vicini a quelli reali, nei limiti consentiti dai processi di stampa.

The colours and appearance features of the products are as close as possible to reality, within the limitation of the printing process.

Die Farben und die ästhetischen Eigenschaften der Produkte entsprechen der Wirklichkeit, innerhalb den von dem Druckverfahren erlaubten Grenzen.

Les couleurs et les caractéristiques esthétiques sont fidèles aux couleurs et caractéristiques réelles dans les limites des procédés d'impression.



Ceramics of Italy rappresenta la volontà dell'industria italiana delle piastrelle di ceramica nel diffondere e promuovere una nuova valenza della piastrella di ceramica: non più solo un prodotto per l'industria delle costruzioni, ma punto di riferimento per stile e creatività per lo sviluppo di una nuova cultura dell'abitare Made in Italy.

Ceramics of Italy represents the willingness of the Italian ceramic tile industry to spread and promote a new concept of ceramic tile: no longer just a product for the construction industry, but a focal point for style and creativity in the development of a new culture of living Made in Italy.

#### Una storia tutta italiana

Piemme dal 1962 è protagonista indiscussa del vero Made in Italy, quello fatto di eccellenza, passione e creatività. Oggi tutti i materiali Piemme sono realizzati con tecnologie d'avanguardia. L'adozione di un innovativo forno di 170m, che recupera il calore per il nuovo essiccatoio "Zero Fuel", insieme alla macchina di pressatura "Continua", ha consentito di ottimizzare l'efficienza energetica e di ridurre significativamente l'impatto ambientale.

#### An all-Italian story

Since 1962, Piemme has been an undisputed protagonist of true Made in Italy, characterized by excellence, passion, and creativity. Today, all Piemme materials are produced using cutting-edge technologies. The adoption of an innovative 170-meter kiln, which recovers heat for the new "Zero Fuel" dryer, along with the pressing machine "Continua", has optimized energy efficiency and significantly reduced environmental impact.

#### Eine ganz italienische Geschichte

Seit 1962 ist Piemme ein unbestrittener Protagonist des echten Made in Italy, das durch Exzellenz, Leidenschaft und Kreativität geprägt ist. Heute werden alle Materialien von Piemme mit modernsten Technologien hergestellt. Der Einsatz eines innovativen 170-Meter-Ofens, der die Wärme für den neuen «Zero Fuel»-Trockner zurückgewinnt, zusammen mit der «Continua» Pressmaschine, hat es ermöglicht, die Energieeffizienz zu optimieren und die Umweltbelastung erheblich zu reduzieren.

#### Une histoire toute italienne

Depuis 1962, Piemme est un acteur incontesté du véritable Made in Italy, incarnant excellence, passion et créativité. Aujourd'hui, tous les matériaux de Piemme sont fabriqués avec des technologies de pointe. L'adoption d'un four innovant de 170 mètres, qui récupère la chaleur pour le nouveau séchoir «Zero Fuel», ainsi que la presse «Continua», a permis d'optimiser l'efficacité énergétique et de réduire considérablement l'impact environnemental.

CERAMICHE PIEMME  
FLOOR AND MORE

INDUSTRIE CERAMICHE PIEMME S.P.A.  
VIA DEL CROCIALE 42/44, 41042 FIORANO (MO) - ITALY  
T. +39 0536.849111 - F. +39 0536.849402  
WWW.CERAMICHEPIEMME.IT - INFO@CERAMICHEPIEMME.IT

