



MARBLE & ONYX
COLLECTION



ROMA

50
Anniversary
| 1973 | 2023

Tagina
ITALY'S BEST SURFACES

ROMA

Pregiati travertini italiani, sinuosi onici mediorientali, variegati marmi africani: i materiali più ricchi e preziosi dei domini romani li troviamo nei rivestimenti di uno dei più affascinanti monumenti dell'impero: il Pantheon. Una molteplicità di generi e stili come a rappresentare la diversità tra tutti gli Dei ai quali tale tempio era dedicato. Sono questi stili, questi colori, questa forza che hanno ispirato la collezione **ROMA**, una serie classica e preziosa che ha saputo domare e fondere in un progetto unico quanto originale tutti i diversi caratteri distintivi di ciascuno di questi superbi materiali naturali.

Fine Italian travertine, sinuous Middle Eastern onyx, variegated African marble: the richest and most precious materials of the Romans can be found in the coverings of one of the most fascinating monuments of the empire: the Pantheon. A multiplicity of genres and styles as if to represent the diversity of all the Gods this temple was dedicated to. It is these styles, these colours, this strength that inspired the **ROMA** collection, a classic and precious series that has been able to tame and merge into a unique and original project all the different distinctive features of each of these superb natural materials.

Précieux travertins italiens, onyx sinueux du Moyen-Orient, marbres africains chamarrés : les matériaux les plus riches et les plus précieux des domaines romains se retrouvent dans le revêtement de l'un des monuments les plus fascinants de l'empire : le Panthéon. Une multitude de genres et de styles comme pour représenter la diversité de tous les dieux auxquels ce temple était dédié.

Ce sont ces styles, ces couleurs, cette force qui ont inspiré la collection **ROMA**, une série classique et précieuse qui a su apprivoiser et fusionner tous les différents traits distinctifs de chacun de ces superbes matériaux naturels en un projet unique et original.

Kostbare italienische Travertine, gewundene Onyx aus dem Nahen Osten, vielfältig melierter afrikanischer Marmor: die reichsten und kostbarsten Materialien der römischen Domänen finden sich in der Verkleidung eines der faszinierendsten Monumente des Reiches wieder: dem Pantheon. Eine Vielzahl von Genres und Stilen, als ob sie die Vielfalt aller Götter, denen dieser Tempel gewidmet war, darstellen sollte.

Es sind diese Stile, diese Farben, diese Kraft, die die Kollektion **ROMA** inspiriert haben, eine klassische und hochwertige Serie, die es verstanden hat, die unterschiedlichen Merkmale dieser herrlichen Naturmaterialien zu bändigen und in einem ebenso einzigartigen wie originellen Design zu vereinen.

100% Made in Italy

COLORI . Colours . Couleurs . Farben



ARGOS

P. 2



EFESO

P. 10



TOLOSA

P. 6

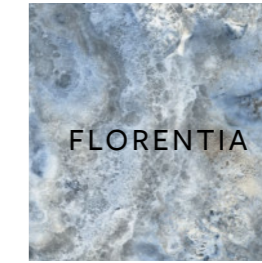

FLORENTIA

P. 18



COLONIA

P. 14

SUPERFICIE . Surface . Surface . Oberfläche



Con la finitura VELVET la piastrella diventa vissuta: una finitura innovativa, semilucida, vellutata al tatto, che rende il suo stile ancor più intenso. La materia setosa e ondulata simula il "consumo del tempo" e veste di prestigio tutti gli ambienti.

With the VELVET finishing, the tile becomes "lived": an innovative, semi-gloss finishing, velvety to the touch, which makes its style even more intense. The silky and wavy material simulates the "consumption of time" and dresses all environments with prestige.

Avec la finition VELVET, le carreau devient authentique : une finition innovante, semi-brillante, veloutée au toucher, qui rend son style encore plus intense. Le matériau soyeux et ondulé simule « l'usure du temps » et habille toutes les pièces avec élégance.

Mit dem VELVET-Finish wird die Fliese lebendig: eine innovative, halbgänzende Oberfläche, die sich samtig anfühlt und ihren Stil noch intensiver macht. Das seidige, gewellte Material simuliert die „Abnutzung durch den Lauf der Zeit“ und verleiht allen Räumen ein prestigevolles Aussehen.



ARGOS



RIVESTIMENTO . WALL: ARGOS 30x60 Velvet Ret.
PAVIMENTO . FLOOR: ARGOS 60x120 Velvet Ret.



RIVESTIMENTO - WALL: ARGOS 30x60 Velvet Ret. - TOLOSA 60x120 Velvet Ret.
BANCONI - COUNTER: Collection APOGEO, WHITE Nat. Ret. 6 mm
PAVIMENTO - FLOOR: ARGOS 60x120 Velvet Ret. - TOLOSA 60x120 Velvet Ret.



TOLOSA



RIVESTIMENTO . WALL: TOLOSA 60x120 Velvet Ret.
BANCONI . COUNTER: Collection APOGEO, WHITE Nat. Ret. 6 mm
PAVIMENTO . FLOOR: ARGOS 60x120 Velvet Ret. - TOLOSA 60x120 Velvet Ret.



RIVESTIMENTO . WALL: TOLOSA 60x120 Velvet Ret.
BANCONE . COUNTER: Collection APOGEO, WHITE Nat. Ret. 6 mm
PAVIMENTO . FLOOR: ARGOS 60x120 Velvet Ret. - TOLOSA 60x120 Velvet Ret.



EFESO







COLONIA



RIVESTIMENTO - WALL:
COLONIA 30x60 Velvet Ret.
Coprispigo Triangolare COLONIA 1,4x120 Velvet Ret.
Mosaico Appia COLONIA 27,6x27,6 Velvet Ret.

PAVIMENTO - FLOOR:
COLONIA 60x120 Velvet Ret.
Mosaico Appia COLONIA 27,6x27,6



RIVESTIMENTO - WALL:
COLONIA 30x60 Velvet Ret.
Mosaico Appia COLONIA 27,6x27,6 Velvet Ret.
Coprispigolo Triangolare COLONIA 1,4x120 Velvet Ret.

PAVIMENTO - FLOOR:
COLONIA 60x120 Velvet Ret.
Mosaico Appia COLONIA 27,6x27,6

MOBILE BAGNO - Vanity:
Collection EVOQUE, BAHIA 26,5x180 Nat. Ret.

Angolo SPA - SPA Area
Mosaico Appia COLONIA 27,6x27,6
Collection EVOQUE, BAHIA 20x120 Nat. Ret.



FLORENTIA



RIVESTIMENTO . WALL: Mosaico Esagona FLORENTIA 28x29 - FLORENTIA 60x120 Velvet Ret.
PAVIMENTO . FLOOR: FLORENTIA 60x120 Velvet Ret.



RIVESTIMENTO . WALL: Mosaico Esagona ARGOS 28x29 - FLORENTIA 60x120 Velvet Ret.
PAVIMENTO . FLOOR: ARGOS 60x120 Velvet Ret.



RIVESTIMENTO . WALL: FLORENTIA 10x30 Velvet Ret.
PAVIMENTO . FLOOR: FLORENTIA 60x120 Velvet Ret.

Spessore . Thickness . Epaisseur . Stärke - 9 mm

Gres porcellanato colorato in massa. Full-body coloured porcelain stoneware. Grès cérame coloré dans la masse. In der Masse gefärbtes Feinsteinzeug.

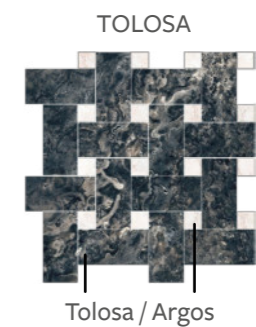
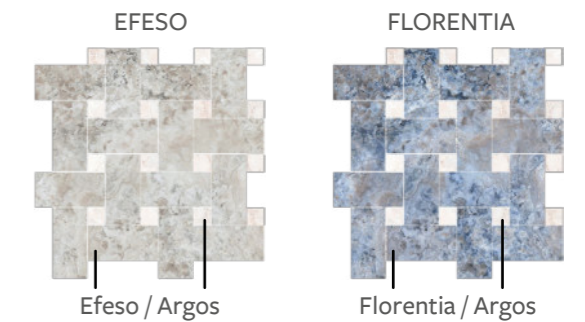
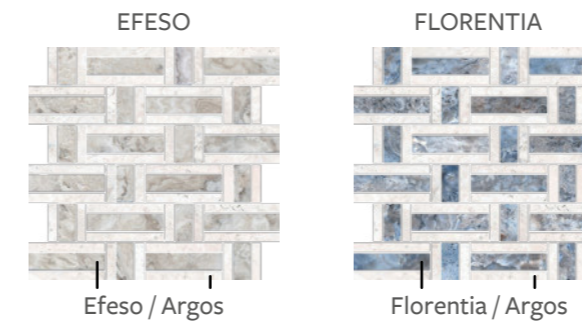
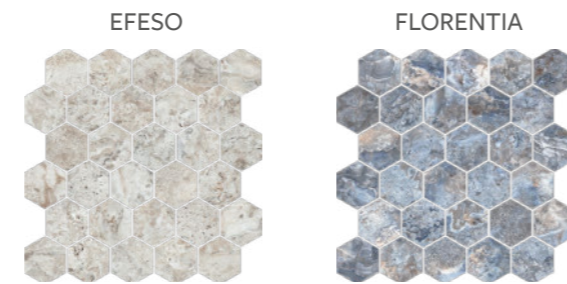
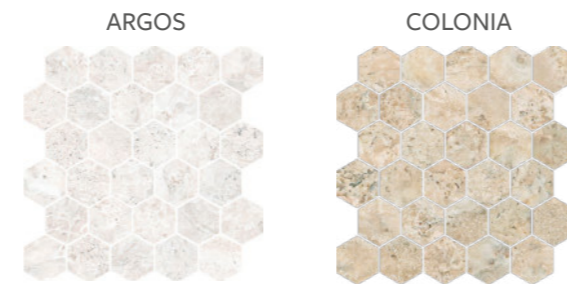

Spessore . Thickness . Epaisseur . Stärke - 9 mm

Gres porcellanato colorato in massa. Full-body coloured porcelain stoneware. Grès cérame coloré dans la masse. In der Masse gefärbtes Feinsteinzeug.

TABELLA RIEPILOGATIVA

Summary table
Tableau récapitulatif
Zusammenfassende Tabelle

			60x120 24"x48"	30x60 12"x24"	10x30 4"x12"	Mosaico (5x5) 30x30 12"x12"	Mosaico Appia 27,6x27,6 11"x11"	Mosaico Esagona 28x29 11"x11 1/2"	Mosaico Emilia 30x30 12"x12"	*** Copriscigolo triangolare 1,4x120 1/2"x48"	Ang. Copriscigolo triang. 1,4x1,4 1/2"x 1/2"	Battiscopa 6,3x120 2 1/2"x48"	* Gradino a C 33x120x3,2h 13"x48"x1 1/4" h	* Ang. Gradino a C - SX 33x120x3,2h 13"x48"x1 1/4" h	* Ang. Gradino a C - DX 33x120x3,2h 13"x48"x1 1/4" h	
SPESSORE - THICKNESS - EPAISSEUR - STÄRKE			9 mm	9 mm	9 mm	9 mm	9 mm	9 mm	9 mm	9 mm	9 mm	9 mm	9 mm	9 mm	9 mm	9 mm
	ARGOS	◇ Velvet Ret.	132002	132062	132082	132302	132322	132342	132362	132402	132422	132102	132202	132234	132222	
	COLONIA	◇ Velvet Ret.	132004	132064	132084	132304	132324	132344	132364	132404	132424	132104	132204	132238	132224	
	EFESO	◇ Velvet Ret.	132008	132068	132088	132308	132328	132348	132368	132408	132428	132108	132208	132240	132228	
	TOLOSA	◇ Velvet Ret.	132010	132070	132090	132310	132330	132350	132370	132410	132430	132110	132210	132242	132230	
	FLORENTIA	◇ Velvet Ret.	132012	132072	132092	132312	132332	132352	132372	132412	132432	132112	132212	132244	132232	
IMBALLI - PACKAGING EMBALLAGE - VERPACKUNG																
			Pallet	Pallet	Pallet	Pallet	Pallet	Pallet	Pallet			Pallet	Pallet	Pallet	Pallet	
			80x120	80x120	80x120	80x120	80x120	80x120	80x120			80x120	80x120	80x120	80x120	
N°																
m²																
** Kg																
			2	6	20	11	11	11	6	6		9	2	1	1	
m² x			1,44	1,08	0,6	0,99	0,83	0,89	0,54							
Kg x			28,3	21	11,5	19,5	16,5	17,5	10,7	2		14,2	22,9	11,5	11,5	
			30	40	72											
m² x			43,2	43,2	43,2											
** Kg x			869	860	848											
h x			74	76	73											
Imballo (Tara) - Packaging (Tare)			(20)	(20)	(20)	(20)	(20)	(20)	(20)			(20)	(20)	(20)	(20)	

I pesi riportati in tabella sono indicativi e potrebbero essere soggetti a leggere variazioni.
The weights stated in the chart may undergo slight changes for production reasons.
Les poids indiqués dans le tableau peuvent subir de légères variations pour des raisons de production.
Die in der Tabelle angegebenen Gewichte können aus Produktionsgründen geringfügigen Abweichungen unterliegen.

Non si garantisce l'abbinabilità tra fondi di spessori diversi e tra fondo e pezzo speciale.
It is not guaranteed that background tiles with different thicknesses can be used together, nor is it guaranteed for background tiles and trims.
Nous ne garantissons pas la possibilité de combiner des carrelages de sol de différentes épaisseurs et un carrelage de sol avec une pièce spéciale.
Die Kombinierbarkeit von Fliesen unterschiedlicher Stärke sowie zwischen Fliese und Formteil kann nicht garantiert werden.

* A disposizione solo su richiesta. Tempi di consegna 30 gg.
Available upon request only. Delivery terms: 30 days.
Disponible seulement sur requête. Délais de livraison: 30 jours.
Verfügbar auf Anfrage. Lieferzeit: 30 Tage.

** Il peso è comprensivo dell'imballo.
The total weight includes the packaging.
Le poids comprend aussi l'emballage.
Das Gesamtgewicht enthält auch die Verpackung.

*** Vendita a scatola completa.
Full box sale.
Vente à la boîte complète.
Voll Kartons.

◇ Velvet rettificato.
Velvet rectified.
Velvet rectifié.
Velvet rektifiziert.

Pezzi speciali: massima cura in ogni dettaglio

Special pieces: the utmost care in every detail.

Pièces spéciales : le soin maximal dans le moindre détail.

Spezialteile: maximale Sorgfalt in jedem Detail.



Il fascino tradizionale del gradino a "C"

The traditional appeal of the "C" step.

Le charme traditionnel de l'étape « C »

Der traditionelle Charme der „C“-Stufe.

Tagina pone attenzione a tutte le componenti architettoniche degli spazi da abitare. Ai gradini sono dedicati pezzi speciali appositamente progettati per ottenere il massimo risultato estetico. La gamma comprende un elemento "gradino a C" al quale si possono affiancare gli elementi che completano gli angoli sinistro e destro.

Tagina takes great care over all the architectural elements of the living spaces. Special pieces are used for the stairs, specially designed to obtain the maximum aesthetic result. The range includes a "C-step" element which can be combined with the elements that complete the left and right corners.

Tagina prête attention à toutes les composantes architecturales des espaces de vie. Les étapes sont dédiées à des pièces spéciales spécialement conçues pour obtenir un résultat esthétique maximal. La gamme comprend un élément « marche en C » auquel vous pouvez assortir les autres éléments qui complètent les angles gauche et droit.

Tagina achtet auf alle architektonischen Komponenten der Wohnräume. Den Stufen sind Spezialteile gewidmet, um ein optimales ästhetisches Ergebnis zu erzielen. Das Sortiment umfasst ein „C-Stufen-Element“, das durch Elemente zur Vervollständigung der linken und rechten Ecke ergänzt werden kann.

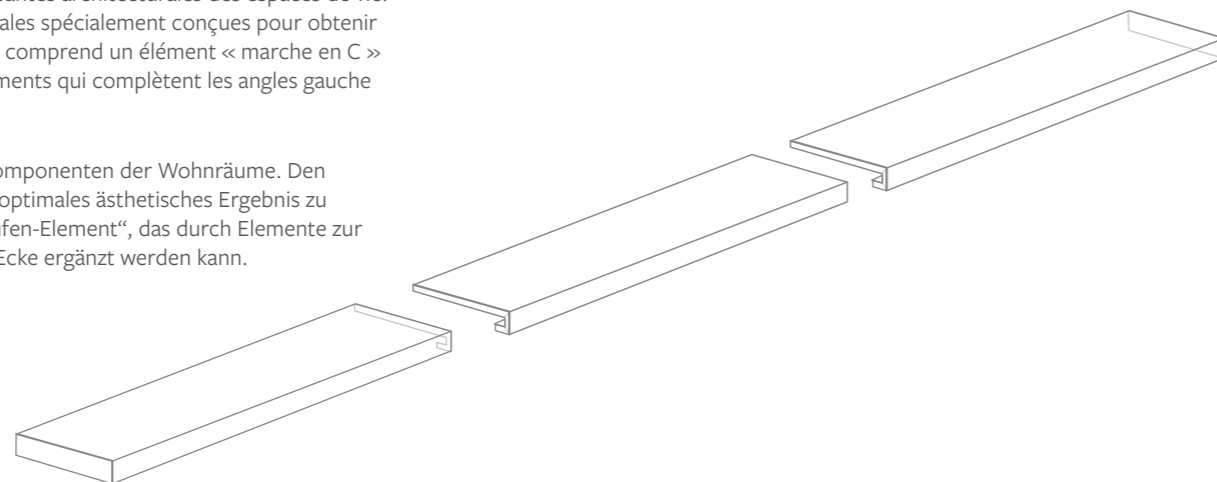

Il "coprispigolo triangolare"

The "triangular edge cover".

Le « cache-arête triangulaire »

„Dreieckiger Kantenschutz“

La gamma della collezione include l'elemento "Coprispigolo triangolare" e "Angolo Coprispigolo triangolare". Consentono di risolvere con eleganza e semplicità problematiche legate alla congiunzione delle lastre in presenza di spigoli e angoli. È possibile adottare questa soluzione sia a rivestimento che a pavimento ad esempio per realizzare gradini o per comporre volumi geometrici.

The range of the collection includes the "Triangular edge cover and triangular corner edge cover" element. They allow problems encountered to be solved elegantly and simply when joining slabs where there are edges and corners. It is possible to adopt this solution both for cladding and flooring, e.g. to create steps or compose geometric volumes.

La gamme de la collection comprend l'élément « Cache-arête triangulaire et Angle Cache-arête Triangulaire ». Ils permettent de résoudre avec élégance et simplicité les problèmes liés à l'assemblage des dalles en présence de bords et de coins. Il est possible d'adopter cette solution aussi bien pour le revêtement que pour le dallage, par exemple pour créer des marches ou composer des volumes géométriques.

Das Sortiment der Kollektion umfasst das Element „Dreieckiger Kantenschutz und Dreieckige Eckabdeckung“. Beide Elemente ermöglichen, mit Eleganz und Einfachheit alle Probleme zu lösen, die mit dem Zusammenfügen der Platten bei Vorhandensein von Kanten und Ecken zusammenhängen. Diese Lösung kann sowohl für Verkleidungen als auch für Böden verwendet werden, beispielsweise um Stufen oder geometrische Volumen zu schaffen.



Suggerimenti per abbinare colori e stili Tagina















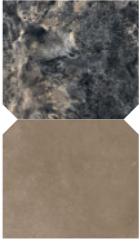
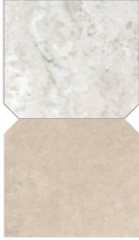



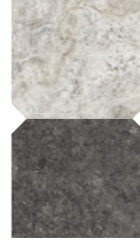



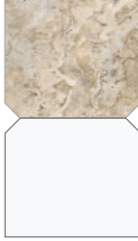
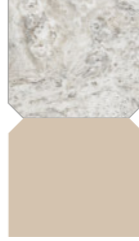

Tips for Matching Colours and Tagina Styles.

Conseils pour faire correspondre les couleurs et les styles Tagina.

Tipps für die Kombination von Tagina-Farben und -Stilen.

PAVIMENTO - FLOOR:
COLONIA 60x120 Velvet Ret.
Mosaico Appia COLONIA 27,6x27,6

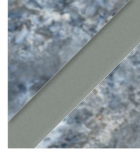
Angolo SPA - SPA Corner
Mosaico Appia COLONIA 27,6x27,6
Collection EVOQUE, BAHIA 20x120 Nat. Ret.

	ARGOS	COLONIA		EFESO	FLORENTIA	TOLOSA
CONCRETE & DESIGN						
ROMA CONCRETA	 TERRA	 TERRA	 GRIGIO CHIARO	 GRIGIO CHIARO	 GRIGIO SCURO	 TERRA
ROMA APOGEO	 WHITE	 ANTHRACITE	 GREY	 GREY	 BLACK	 WHITE
ROMA FULL COLOURS	 CLOUD	 SHADOW	 MOON	 DESERT	 SHADOW	 CLOUD
WOOD	 DOUSSIE	 BAHIA	 ROVERE	 KORINA	 DOUSSIE	
Colore consigliato per la Fuga Recommended joint colour. Couleur d'échappement recommandée. Empfohlene Farbe für die Fuge.	 RAL 9010 NCS 1002-Y	 RAL 1015 NCS 1010-Y40R	 RAL 7044 NCS 2703-Y	 RAL 7042 NCS 3502-B	 RAL 7022 NCS 8005-G20Y	

Per le condizioni generali di vendita e le caratteristiche tecniche consultare www.tagina.it
General terms and Sales conditions and Technical features are available on our website www.tagina.it
Les Conditions général de vente et les Caractéristiques techniques sont disponibles sur le site web www.tagina.it
Allgemeine Verkaufsbedingungen und technische Eigenschaften sind auf unsere Website verfügbar: www.tagina.it

Tagina S.p.A. si riserva di modificare, senza alcun preavviso, il packaging dei prodotti, le grafiche, i colori e i decori riportati nelle immagini che sono pertanto da ritenersi indicative.
Tagina S.p.A. reserves the right to change the product packaging, the patterns, colours and decorations shown in the pictures without any prior notice. These aspects, therefore should be considered for illustrative purposes only.
Tagina S.p.A. se réserve le droit de modifier, sans préavis, l'emballage des produits, les graphismes, les couleurs et les décors représentés dans les images, fournies à titre indicatif.
Die Tagina S.p.A. behält sich vor, die Verpackung der Produkte, die in den Abbildungen gezeigten Grafiken, Farben und Dekors sowie ohne vorherige Ankündigung zu ändern.



Tagina S.p.A.
Via Emilia Ponente, 925
48014 Castel Bolognese (RA) - Italy
Tel. +39 0545 197 7303

tagina.it -  DAFIN GROUP



Follow us